

SMOOTH FIBERGLASS, TEXTURED FIBERGLASS & STEEL ENTRY DOORS

**CODEL**  
ENTRY SYSTEMS™



**CODEL**  
COATINGS

*Paint or Stain, We've Got You Covered!*



SFHER-206 door with C-21 craftsman shelf.



# CODEL

## ENTRY SYSTEMS™

### Complete & Ontime DELivery!

*Featuring Smooth Fiberglass, Textured Fiberglass & Steel Entry Systems.*

## Table of Contents

CodeL Distinct Features .....	4
The CodeL Door Difference .....	5
WeatherGuard .....	6
Hinges.....	7
Sills.....	8-9
Adjustable Sill Pan & Aluminum Nailing Flange.....	10
Hoppe Multipoint Hardware .....	11
Rockwell Multipoint & Standard Hardware.....	12-14
Contemporary Door Pulls.....	15
CodeL Coatings.....	16-17
Breezeway Collection.....	18
Raise & Lower Mini Blind Collection .....	19
Smooth Fiberglass Standard Collection.....	20-22
Smooth Fiberglass Flush-Glazed Collection.....	23-25
Oak Grain Textured Fiberglass Standard Collection .....	26-27
Oak Grain Textured Fiberglass Flush-Glazed Collection.....	28-29
Fir-Grain Textured Fiberglass Collection .....	30-31
Shaker Fiberglass Collection .....	32
“True White” Oak Grain Textured Fiberglass Collection .....	33
Single-Hinged Inswing Fiberglass Patio Doors .....	34-35
Obscure Glass Options .....	36-37
Steel Standard Collection.....	38-39
90-Minute “Fast-Frame” Fire Doors.....	40-41
6-8 & 7-0 Contemporary Classics Collection.....	42-43
8-0 Contemporary Classics Collection .....	44-45
Decorative Contemporary Classics Collection.....	46-47
Teak Grain Textured Fiberglass .....	47
6-8 Standard Craftsman Collection.....	48-49
6-8 Smooth Fiberglass Heritage Craftsman Collection.....	50-51
8-0 Smooth Fiberglass Heritage Craftsman Collection.....	52-53
6-8 Fir-Grain Fiberglass Heritage Craftsman Collection .....	54-55
8-0 Fir-Grain Fiberglass Heritage Craftsman Collection .....	56-57
Rustic Collection .....	58-59
<b>Decorative Collections</b>	
Palisades .....	60-61
Cirque .....	62-63
Canterbury.....	64-65
Caspian.....	66-67
Brentwood .....	68-69
Maren.....	70-71
Waterton.....	72-73
Artisan .....	74-75
Adelaide.....	76-77
Narrows .....	78-79
Fiora.....	80-81
Modena.....	82-83
Harlow .....	84-85
Floret.....	86-87
Eloquence .....	88-89
Sonora .....	90-91
Vogue.....	92-93
Inspire .....	94-95
Fiberglass Door Textures.....	96
CodeL Door Configurations.....	97
Decorative Transom Sizes & Door Handing .....	98
Prehung Net Unit Measurements.....	99

# Codel Fiberglass Doors Distinct Features

With high-impact compression-molded skins that will not splinter, dent, rot or rust, Codel's smooth and textured fiberglass doors are virtually maintenance free. Unlike other brands of fiberglass doors that offer only wood edges, our door is designed with "Hydroshield Technology"\* and manufactured with full-length matching composite stiles, and high strength composite top and bottom rails. Having no exposed wood is paramount in preventing moisture from seeping into the door. The Codel fiberglass door, when partnered with our WeatherGuard composite frame system, will not only stand up to the elements, but will also provide years of satisfaction.



## LVL Stile

Continuous 3-1/4" lock block extending the full length of the lock-side, keeps the door from bowing and improves security.



## JambGuard™

Heavy duty steel reinforcement plate for added protection and security.

(\*Not on sidelite or double units.)

## Premium High Dam Sill

Provides an improved barrier against air and water intrusion.

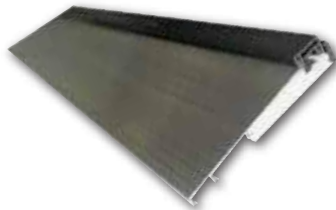

## High Performance Sweep

Provides a tight seal against drafts.



## High Density Polyurethane Foam

Provides 5 times the insulation value of wood doors.

## HydroShield™ Technology\*

Composite framework seals out moisture and eliminates rot and deterioration.

\*Excludes wood edge doors.



## Commercial Ball Bearing Hinges *Standard* on All Fiberglass Doors

This stronger, heavy-duty, hinge keeps your door true and square in the opening, and reduces the risk of sagging.



## Door Install Screws

Additional 2-3/4" screws come standard with every prehung unit. Install one in the middle and bottom hinge and two in the top hinge for added security.



## Primed Wood Jamb and Brickmould

Our domestic Ponderosa pine door frames are treated with blue acrylic end sealer to prevent wicking moisture.

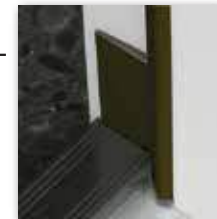

## Corner Seal

Added protection against water and air infiltration.



**CODEL**  
ENTRY SYSTEMS™

**plastpro**  
THE DOOR OF ENTRY AND INSULATION

# What's Inside DOES Make a Difference!

## CODEL ENTRY SYSTEMS Fiberglass Door



Actual Image

## Energy Efficient

Codel doors provide more insulation value than wood doors; and are more efficient than older, worn-out, drafty doors.

### Thermal Performance values established in accordance with ETC Laboratories (NFRC) Simulation Report

	R value	U value	SHGC value
Fiberglass Full Panel door unit w/no glass	6.25	0.16	0.00
Fiberglass door unit w/1/4 Clear Glass	4.35	0.23	0.10
Fiberglass door unit w/1/2 Clear Glass	3.57	0.28	0.19
Fiberglass door unit w/Full Clear Glass	2.70	0.37	0.33
Fiberglass door unit w/1/2 Mini Blind	3.23	0.31	0.14
Fiberglass door unit w/Full Mini Blind	2.56	0.39	0.27
Fiberglass door unit w/1/2 LowE Glass	4.17	0.24	0.16
Fiberglass door unit w/Full LowE Glass	3.45	0.29	0.28
Fiberglass door unit w/1/2 LowE Mini Blind	3.57	0.28	0.11
Fiberglass door unit w/Full LowE Mini Blind	2.94	0.34	0.22
Fiberglass door unit w/1/4 LowE Decorative Glass	5.00	0.20	0.07
Fiberglass door unit w/1/2 LowE Decorative Glass	4.55	0.22	0.13
Fiberglass door unit w/3/4 LowE Decorative Glass	4.17	0.24	0.17
Fiberglass door unit w/Full LowE Decorative Glass	3.85	0.26	0.23
Fiberglass door unit w/Full Flush Glazed Clear Glass	2.56	0.39	0.42
Fiberglass door unit w/Full Flush Glazed LowE Glass	3.70	0.27	0.32

FEATURES	BENEFITS	CODEL ENTRY SYSTEMS	Others
① <b>Hydroshield Technology*</b> Composite Edge Perimeter (No Exposed Wood)	Seals out moisture, greatly reducing its damaging effects such as rotting, bowing and delamination, providing a <i>longer lasting</i> and <i>better performing</i> door over the years.	✓	N/A
② <b>Heavy Duty Full Length Lock Block*</b> (LVL) Laminated Veneer Lumber	Greater <i>strength</i> and <i>stability</i> built into the latch side of the door for sturdy support for hardware and other security features, as well as improved resistance to bowing.	✓	N/A
<b>No Paint Required*</b> Limited Lifetime Warranty	Because Codel fiberglass doors are designed with <i>Hydroshield Technology</i> , doors are not finished, but, painting is not required to maintain the warranty.	✓	N/A
③ <b>Polyurethane Foam Core</b> (100% CFC Free)	Provides greater insulation and energy efficiency than wood doors.	✓	✓
④ <b>Fiberglass Skin</b>	Fiberglass skins won't rot like wood doors or dent like steel doors.	✓	✓

\*Excludes Wood Edge Doors.



SF20F door.

Codel's WeatherGuard Composite Frame System is an innovative alternative to traditional wood jambs. This poly-fiber doorframe system combines all the strength and convenience of wood with enhanced properties that make it moisture, rot and insect resistant. This unique formulation guarantees that the WeatherGuard frame will not absorb or wick moisture and will never warp, splinter or rot.

The WeatherGuard product line is available in two varieties. White Cap is a smooth, semi-gloss white that can be painted or left unfinished to compliment the Codel Smooth Fiberglass door. Textured has an embossed grain that can be painted or stained to compliment the Codel Textured Fiberglass door. The advanced WeatherGuard system can be installed the same way as traditional wood jambs.

Exclusive to WeatherGuard is our patented "Seams-Rite" spline that enables the brick-mould to be applied to the jamb without using nails. Besides eliminating nail holes, "Seams-Rite" ensures a continuous water barrier. An optional vinyl nailing flange is also available.



(Vinyl nailing flange is optional.)

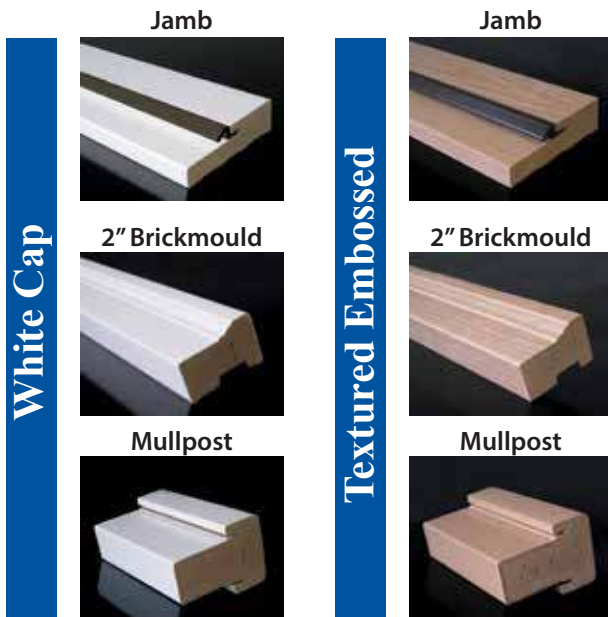

## Features & Benefits

- Poly-fiber composite jamb system is an attractive, affordable, and low maintenance option to traditional wood.
- Closed cellular structure is a unique formulation that ensures product will not warp, split or absorb moisture.
- Greater screw holding power than wood.
- Installs the same as traditional wood jambs.
- Available in smooth semi-gloss white cap and stainable textured embossed.
- Matching mullposts offering sidelite and transom capabilities.
- Installation and finishing recommendation label applied to every frame.
- Limited lifetime warranty.

# High Performance Commercial Grade Ball Bearing Hinges **Standard** on Codel Fiberglass Doors

## Strength and Durability:

Heavy-duty commercial strength hinge, that is much thicker than the standard residential hinge found on most residential fiberglass doors in the industry. This stronger hinge keeps your door true and fit in the opening, and reduces the risk of sagging.

## Smooth Operation:

Our heavy-duty hinges come standard with ball bearings, giving your entry door ease of opening and years of quiet operation.

## Appearance and Security:

With a thickness of 3.3mm, and ¼ radius, these hinges are not only aesthetically pleasing, but are more secure than the traditional residential hinge.



**US15 Satin Nickel**  
(Non-Ferrous or \*Self-Closing Options Also Available)



**US26 Bright Chrome**  
(\*Self-Closing Option Also Available)



**US26D Brushed Chrome**  
(\*Self-Closing Option Also Available)

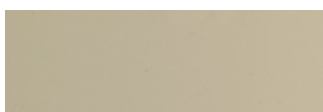

**US3 Brass**  
(Non-Ferrous or \*Self-Closing Options Also Available)



**US5 Antique Brass**  
(Self-Closing Option Available as Special Order.)



**US10B Bronze**  
(Non-Ferrous or \*Self-Closing Options Also Available)



**US32D Stainless Steel**  
(Non-Ferrous)

\*Self-Closing Hinges **ARE NOT** Ball Bearing.

■ Extended Leadtime Required.



**Codel recommends non-ferrous hinges on all outswing doors as steel based hinges may develop rust if they are exposed to moisture.**



**US10B Bronze**  
(Non-Ferrous or \*Self-Closing Options Also Available)

## Steel Door Standard Hinge



Our steel doors come with a standard weight hinge, available in the same color choice options noted above.

## Water-Shed Inswing Sill

# Stop Water At The Door

The first-of-its-kind, Water-Shed sill, is an all-new patent-pending exterior door inswing sill that actually takes any water that might infiltrate past the door sill and sweep, and channels it back outside the home where it belongs.

With its unique design, Water-Shed offers a built-in weep system, giving your entry door an advantage over other door systems. Using the Water-Shed sill on your entry system will help eliminate costly water leaks inside the home.

- Same Price As Traditional Adjustable Sill
- Special Bumper Sweep Compensates for Gaps; No Adjustment Needed
- Stops Costly Leaks

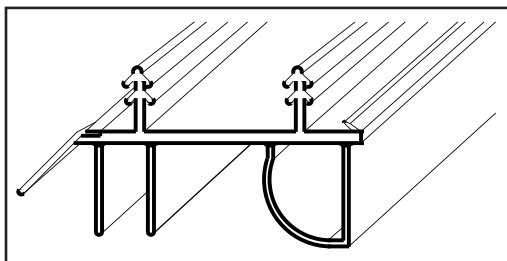
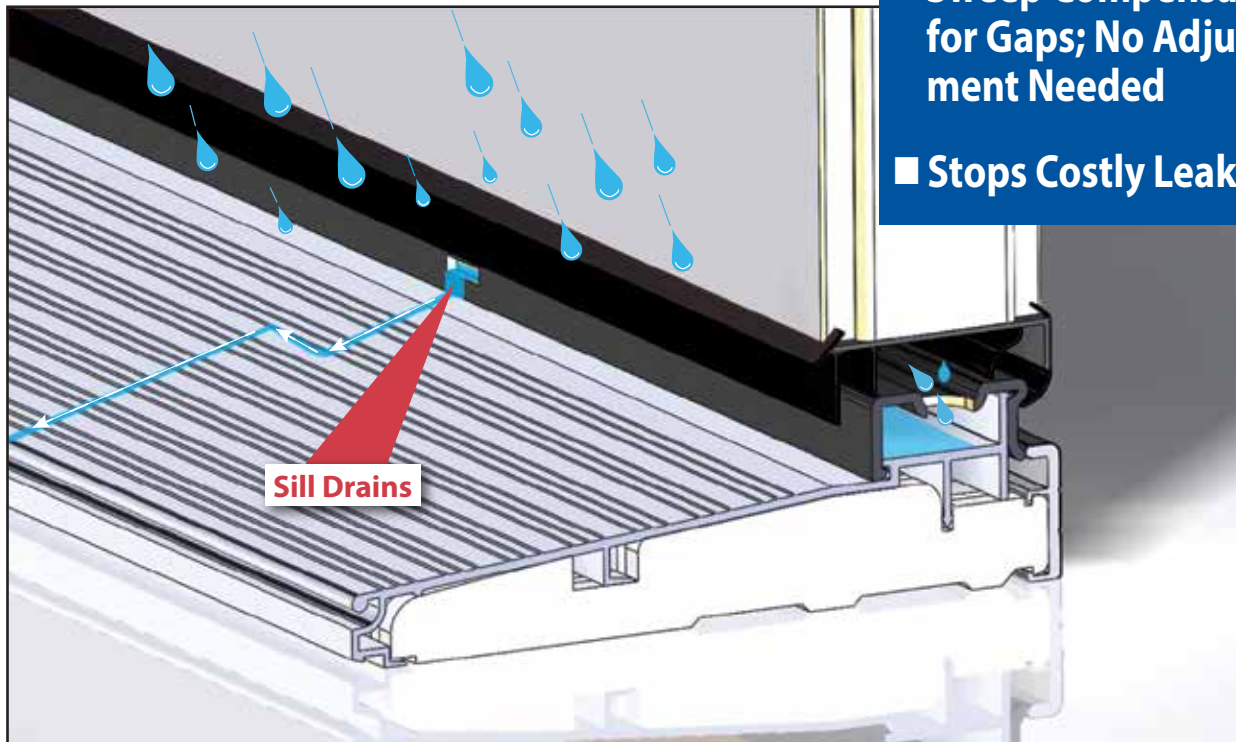

### Durable Sweep

Our black flexible rubber bumper sweep has two fins, large interior bulb, and a built-in exterior fin to deflect water run off. This larger bumper sweep compensates for gaps; no adjusting needed.

### Butyl End Seal Gasket

The butyl end seal gaskets not only bond the sill to the jamb leg, but also provide a tight seal against water infiltration.



**CODEL**  
ENTRY SYSTEMS®

The Water-Shed sill is a patent-pending configuration brought to you by Codel Entry Systems. Contact us to learn more.





## Inswing Water-Shed Sill

- Built-In Weep System
- All Composite for Durability
- Special Bumper Sweep Compensates for Gaps; No Adjustment Needed
- Water-Tight Butyl End Seal Gasket



## Inswing Adjustable Sill

- High Performance Imperial Seal Technology
- All Composite for Durability
- Adjustable Rail Ensuring a Tight Fit
- Water-Tight Butyl End Seal Gasket



## Inswing Fixed Sill

- Thermal Efficient Composite Cap
- Durable Economic Design
- Water-Tight Butyl End Seal Gasket



## Outswing Bumper Sill

- All-Aluminum Durability
- High Performance Outswing Design
- Water-Tight Butyl End Seal Gasket



## Outswing Oak Bumper Sill

- Stain Grade Hardwood Interior
- High Performance Outswing Design
- Water-Tight Butyl End Seal Gasket



## LowPro Sill (Inswing or Outswing)

- ADA Compliant
- Durable All-Aluminum Design
- Not Recommended for High Weather Exposure



**All Sills Available in:**



Mill Finish

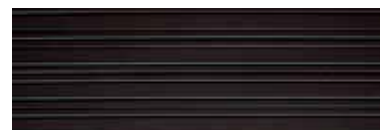

Bronze Finish

## ADJUSTABLE SILL PAN

The Adjustable Sill Pan is a durable, PVC plastic unit that helps you protect your sill and entry door from water damage.

- Sloped weep areas located beneath the Jamb-to-sill joint that direct moisture away from areas that could be damaged.
- Durable weather-resistant material impervious to rust, corrosion, galvanic corrosion electrolysis and corrosive coastal areas.
- Depths to accommodate most door applications in either 2 x 4 or 2 x 6 construction.
- Easy installation with the multiple-piece design.

**Available in  
4-9/16" & 6-9/16"**

**Large  
Glue Tab  
Area For  
Adjustability**

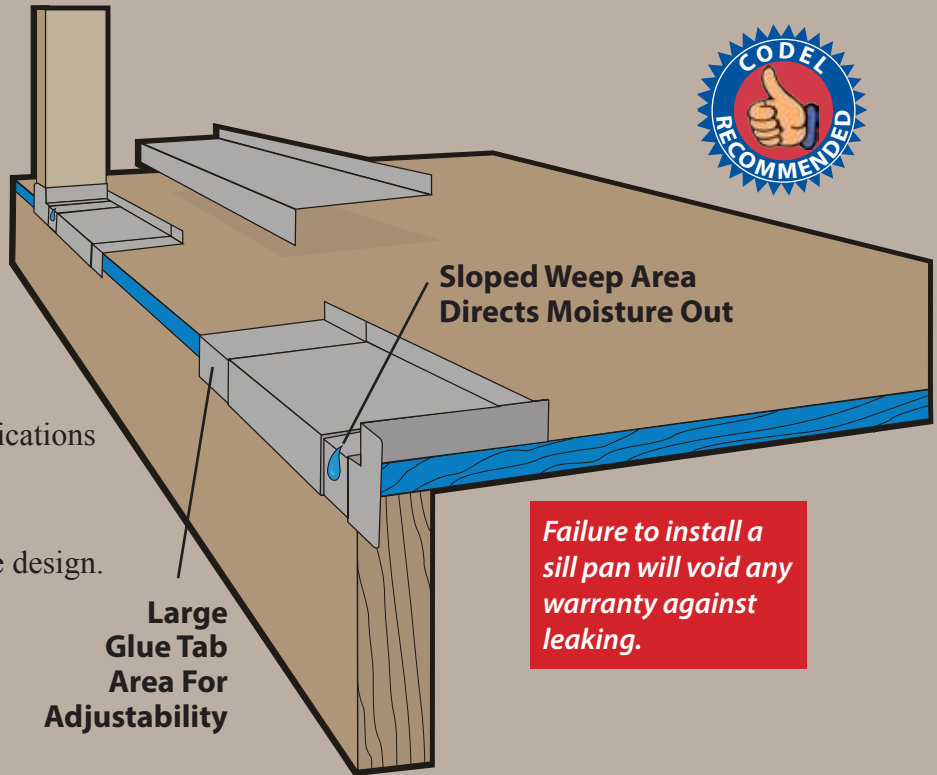

## ALUMINUM NAILING FLANGE

Striking the perfect balance between durability and function, Codel's Aluminum Nailing Flange not only replaces traditional exterior brickmould with a streamlined profile that is weather-resistant and virtually maintenance free, but also reduces installation time, and works as a barrier against air and moisture infiltration. This white Aluminum Nailing Flange can be left as is, or can be painted, providing the flexibility to match most exterior color schemes.

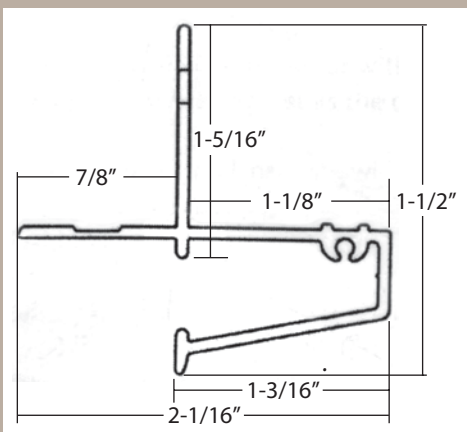

### Features & Benefits

- Reduces install time.
- Made of heavy gauge aluminum for strength and durability.
- Eliminates the need for visible fasteners.
- Provides a surface to use flashing tape for the best seal.
- Slimline brickmould provides a clean transition for all siding applications.
- Can be left white or can be painted.
- Can be used on Primed or WeatherGuard jambs.

Codel Entry Systems offers Multi-Point Locking Systems of the finest design, most precise machining and highest quality materials providing homeowners with a secure locking system stronger than traditional deadbolt locks.



### **Screw Support**

Prevents flexing or bending of the gear for lifetime performance and smoother operation.



### **Mishandling Device**

Prevents multiple locking points from accidentally firing and potentially damaging door trim. Fully field reversible.



### **Solid Stainless Steel Deadbolt**

Highly corrosion resistant and stronger than traditional deadbolts.



### **Manual Tongue (Top & Bottom)**

While offering security in the locked position, the manual tongue engages into the jamb or mull post and retracts when opened, giving a smooth, clean appearance.



### **Flush Bolts (Top & Bottom)**

(Optional) Multi-Point is available for the inactive door. The flush-bolts operate by the handle on the in-active panel, sending the flush-bolts simultaneously into the head and sill, offering a smooth and easy operation and securing your entry door.



**Traditional**



**Contemporary**

Bronze

Brushed Chrome



**Euro**

Satin Nickel

Bronze

## Multi-Point Hardware Options & Finishes

### **Features and Benefits**

- 300 Series Stainless Steel-Highly corrosion resistant.
- Self Lubricating Parts - Last longer by eliminating the need to lubricate locks.
- Helps prevent doors from bowing and adds extra security at the same time.
- Schlage Keyway.

- Only available on Fiberglass door units.  
- Not available on cut-down units.



# MultiPoint - Grip Series

TONGUE LATCH SYSTEM



**Finishes**

*Satin Nickel*      *Bronze*

Multiple locking points maintain door panel integrity, prevent door warpage, improve weather resistance and increase security.



Consumer friendly with 1/4 turn deadbolt lock indicator.

**Savoy**

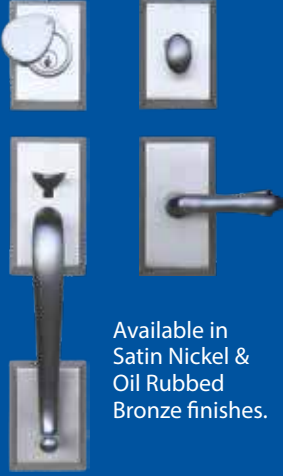

Available in Satin Nickel & Oil Rubbed Bronze finishes.

**Windsor**



Available in Satin Nickel & Oil Rubbed Bronze finishes.

**Lumina**



Available in Satin Nickel & Oil Rubbed Bronze finishes.

## Grip & Lever Series Features

- Available for 6/8, 7/0 and 8/0 Doors.
- Available in Satin Nickel and Oil Rubbed Bronze.
- Conventional Deadbolt and Lever Handle Spacing at 5-1/2".
- Adjustable Strike Plates.
- Dummy Sets Available for Double Door Units.
- Deadbolts & Levers Meet ANSI Grade 2 Standards.
- Schlage Keyway.

Only Available on Fiberglass Door Units.



# MultiPoint - Lever Series

TRIPLE LATCH SYSTEM



3 latches automatically engage when door closes to prevent door warpage and increase security.



Consumer friendly with 1/4 turn deadbolt lock indicator.



Adjustable strikes for optimum operation.



Extended strike for outswing units.

**Finishes**

**Satin Nickel**      **Bronze**

**Bright Chrome**  
(Available on Times Verona ONLY)

**Classique**

Available in Satin Nickel & Oil Rubbed Bronze finishes.

**Classique Monaco**

Available in Satin Nickel & Oil Rubbed Bronze finishes.

**Classique Verona**

Available in Satin Nickel & Oil Rubbed Bronze finishes.

**Times**

Available in Satin Nickel & Oil Rubbed Bronze finishes.

**Times Verona**

Available in Satin Nickel, Oil Rubbed Bronze & Bright Chrome finishes.

**Dahli**

Available in Satin Nickel & Oil Rubbed Bronze finishes.

**Dahli Verona**

Available in Satin Nickel & Oil Rubbed Bronze finishes.

- Grip & Lever Series Features**
- Available for 6/8, 7/0 and 8/0 Doors.
  - Conventional Deadbolt and Lever Handle Spacing at 5-1/2".
  - Adjustable Strike Plates.
  - Dummy Sets Available for Double Door Units.
  - Deadbolts & Levers Meet ANSI Grade 2 Standards.
  - Schlage Keyway.

Only Available on Fiberglass Door Units.





# Standard Grip & Lever Handle Hardware

(Not MultiPoint)

## Zenia (Grip)



Available in Satin Nickel & Oil Rubbed Bronze finishes.

## Venice (Lever)



Available in Satin Nickel & Oil Rubbed Bronze finishes.

## Venice Verona (Lever)



Available in Satin Nickel, Oil Rubbed Bronze & Bright Chrome finishes.

## Chelsea (Lever)



Available in Satin Nickel, Oil Rubbed Bronze & Brass finishes.

### Finishes



*Satin Nickel*



*Bronze*

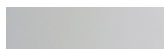

*Bright Chrome*

*(Available on Venice Verona ONLY)*



*Brass*

*(Available on Chelsea ONLY)*

## Standard Grip & Lever Series Features

- Available for 6/8, 7/0 and 8/0 Doors.
- Conventional Deadbolt and Lever Handle Spacing at 5-1/2".
- 2-3/8" Backset x 2-1/8" Face Bore.
- Deadbolts & Levers Meet ANSI Grade 2 Standards.
- Limited Lifetime Warranty.
- Schlage Keyway.



# Contemporary Door Pulls



## Roller Catch

Two heavy-duty roller catches located near the top and bottom of the door ensure a secure closure. Available in Satin Nickel and Oil Rubbed Bronze.



24"  
Round  
Door  
Pull

60"  
Round  
Door  
Pull

## Finishes



Only Available on Fiberglass Door Units.

**CODEL**  
ENTRY SYSTEMS™

# CODEL *We Finish What We Start!*

## COATINGS

### Standard Textured Fiberglass Stain Colors

Have Codel stain your textured fiberglass door today! We have an array of beautiful stain colors to choose from.



Medium Oak

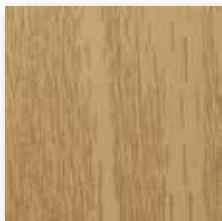

Light Oak

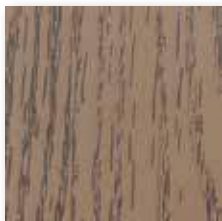

Cinnamon



Cedar



Red Cherry

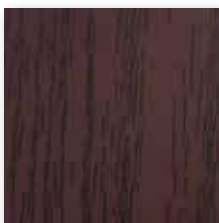

Mahogany

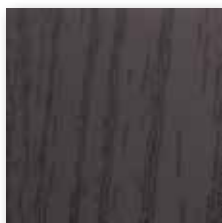

Walnut

*The stain colors shown above are available on ALL Standard Oak, Teak & Rustic Grained Textured Fiberglass doors. (NOT available on Fir Grained doors.)*



*Harlow HAR-430 door with HAR-230 sidelite.*

### Fir Grain Stain Colors

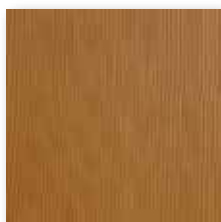

Ginger

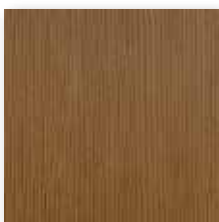

Nutmeg

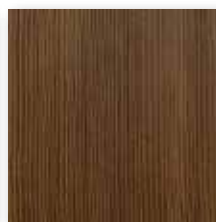

Clove

*Available on Fir-Grain Doors ONLY (See pages 30 - 32, & 54-57).*

#### Why doesn't the color on my product look exactly like it does in the catalog or website?

*Due to the limitations of photography, there is no guarantee that your product's colors will have the same appearance as they do in print or online. We always recommend you see an actual sample before deciding on a color choice. Contact a Codel dealer to request a color chip sample.*



## Standard Paint Colors

Codel will paint any of our smooth or textured fiberglass doors. All you have to do is choose from the wide variety of colors we have to offer!

# CODEL

---

## COATINGS

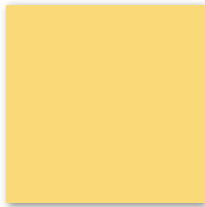

**Daffodil**

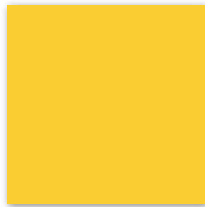

**Fremont**

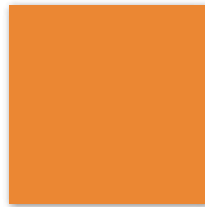

**Ravena**

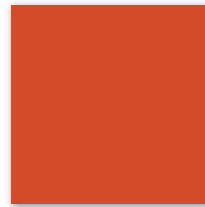

**Proctor**



**Cougar**



**Tomato**

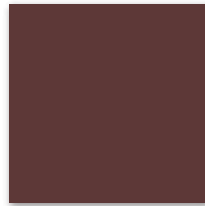

**Burgundy**



**Hunter**



**Magnolia**



**Artichoke**



**Navy**



**Pacific**



**Ballard**



**Denim**

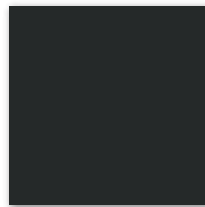

**Carbon**



**Iron**

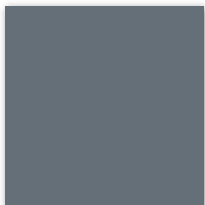

**Flint**

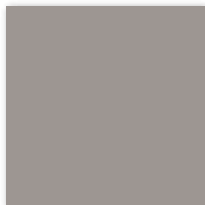

**Concrete**

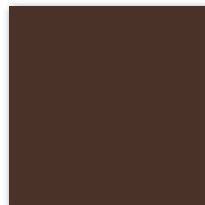

**Espresso**

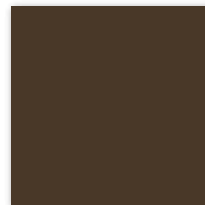

**Truffle**

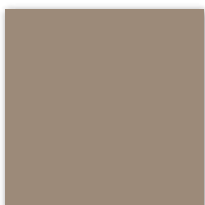

**Taupe**



**Sand**

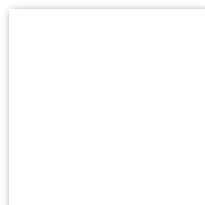

**Bright**

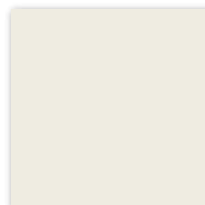

**Ivory**

*Artichoke Paint*

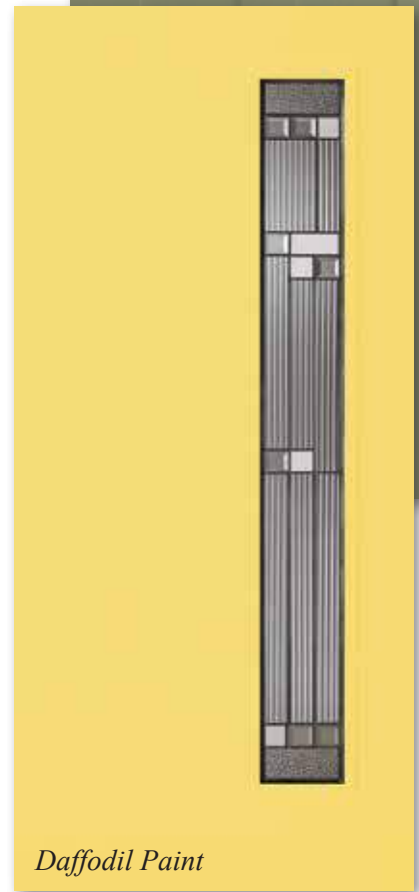

*Daffodil Paint*

**Paint or Stain,  
We've Got  
You Covered!**

# BREEZEWAY COLLECTION



20V

6V



S  
SF  
TF

S  
SF  
TF

## Features & Benefits

- Vented lite kit complete with removable screen.
- Maintenance free frame.
- Ergonomic handle design for easy lite kit operation.
- Reinforced latch system secures glass in open position.
- Venting lite allows for maximum air flow.
- One piece screen can be easily removed.
- Eliminates the need for a storm door.
- Tempered safety glass.
- Available in Clear & ■ Low-E glass.

**CODEL**  
ENTRY SYSTEMS™

# RAISE & LOWER MINI BLIND COLLECTION

Fully Raise and Lower Blind with Ease!

61MB



SL1MB



20MB

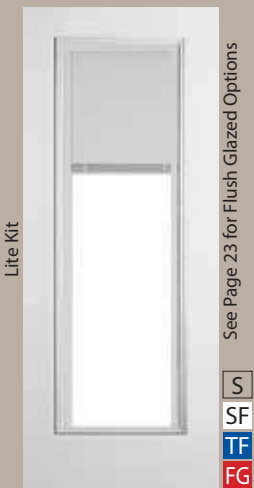

SL20MB

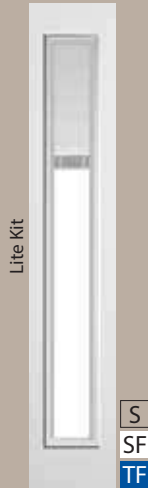

See Page 23 for Flush Glazed Options

No dusting!  
Blinds are  
sealed  
between  
tempered  
safety glass.

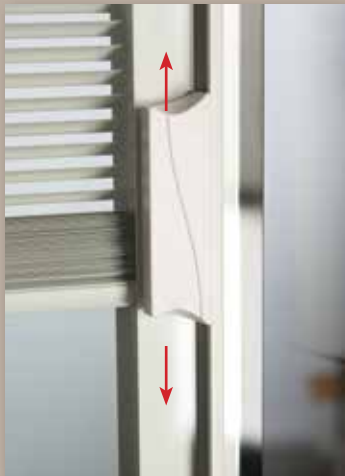

LIMITED  
**20**  
YEAR  
WARRANTY



Smooth Fiberglass 20MB doors.

## Smooth Fiberglass Collection

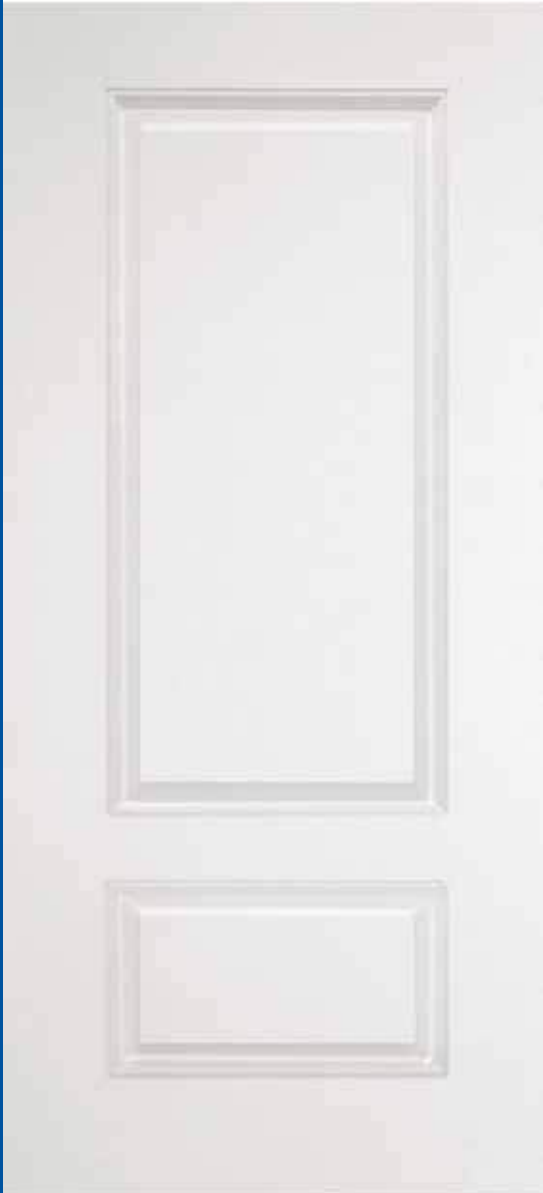

SF2PL door.

### Key Code Chart

GBG ..... Available w/Grids between Glass

LE ..... Available w/Low-E Glass

● ..... Available in 7<sup>0</sup> Height

▲ ..... Available in 8<sup>0</sup> Height

■ ..... Extended Leadtime Required

◆ ..... Available w/Panic Blocking/  
Closure Reinforcement (6-8 Only)

🔥 ..... 20-Min. Fire Rated (\*6-8 Only, 3-0 Max Width.)

<p><b>SFF/SFF20</b></p> <p>20 24 ●▲26 ◆▲28 210 ◆▲30 ●▲36 40</p> <p>*20-Minute Option Available in 2-8 &amp; 3-0 (6/8) Only</p> <p>4-0 has no warranty against bowing or wavy skin.</p>	<p><b>SF6P/SF6P20</b></p> <p>▲26 ●▲28 210 ◆▲30</p> <p>*20-Minute Option Available in 2-8 &amp; 3-0 (6/8) Only</p>	<p><b>SF4P</b></p> <p>28 ●▲30</p>
<p><b>SF66</b></p> <p>30</p>	<p><b>SF93</b></p> <p>30</p>	<p><b>SF3PSHK</b></p> <p>28 210 ▲30 ▲36 (8/0 Only Composite Edges) Wood Edge</p> <p>See Page 51 For Optional Craftsman Shelf, Glass and Sidelite Options.</p>
<p><b>SF64GBG</b></p> <p>◆▲30</p> <p>GBG only</p>	<p><b>SF648CL</b></p> <p>●28 210 ●30</p>	<p><b>SFW</b></p> <p>28 210 ◆30</p> <p>Fixed Grids Standard</p>
<p><b>SF61MB</b></p> <p>26 ●28 210 ◆30</p> <p>Raise &amp; Lower Mini Blinds</p> <p>LE 2-8, 2-10, 3-0 ■ LE 2-6</p>	<p><b>SF81</b></p> <p>28 ▲30 36 (8/0 Only)</p> <p>LE</p>	<p><b>SF6SDLSP</b></p> <p>28 30</p> <p>Simulated Divided Lite No Matching Sidelites Available.</p>

**We Finish What We Start!**

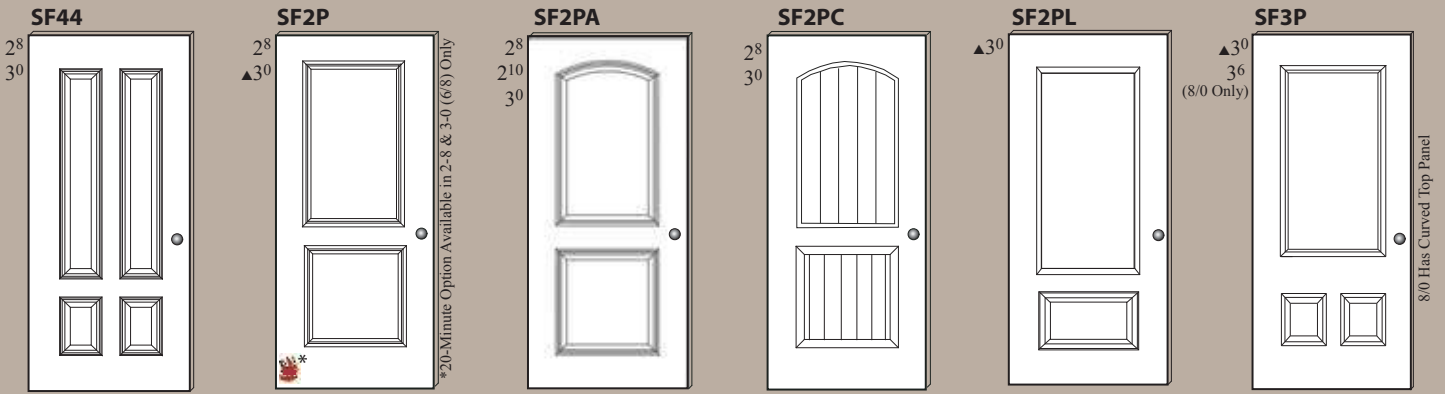

8/0 Has Curved Top Panel

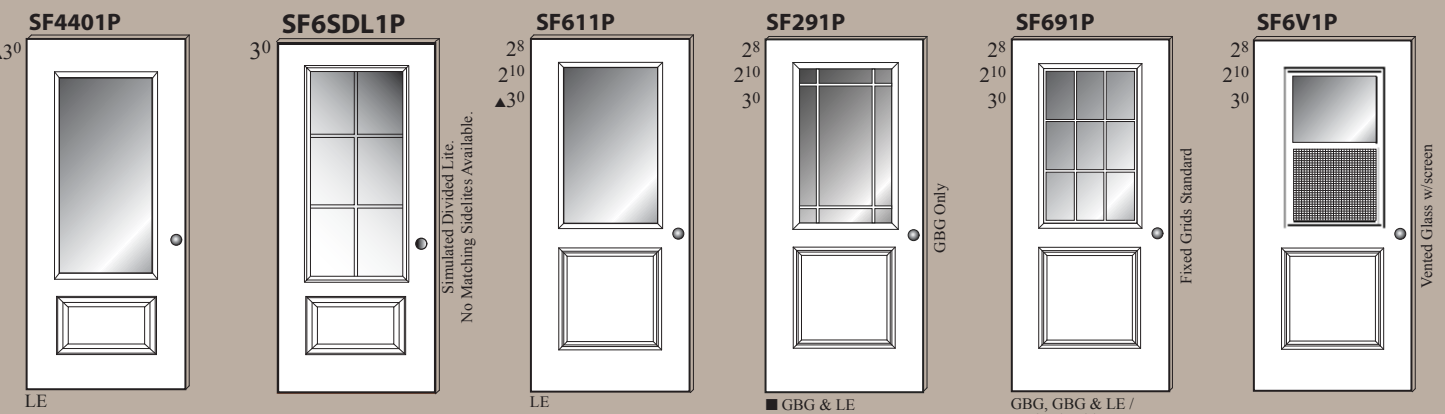
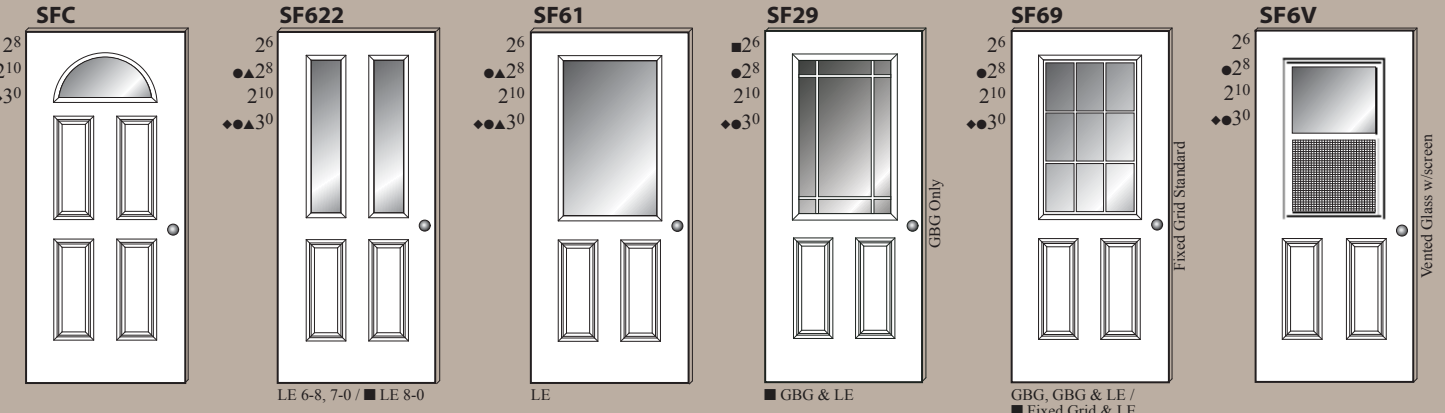
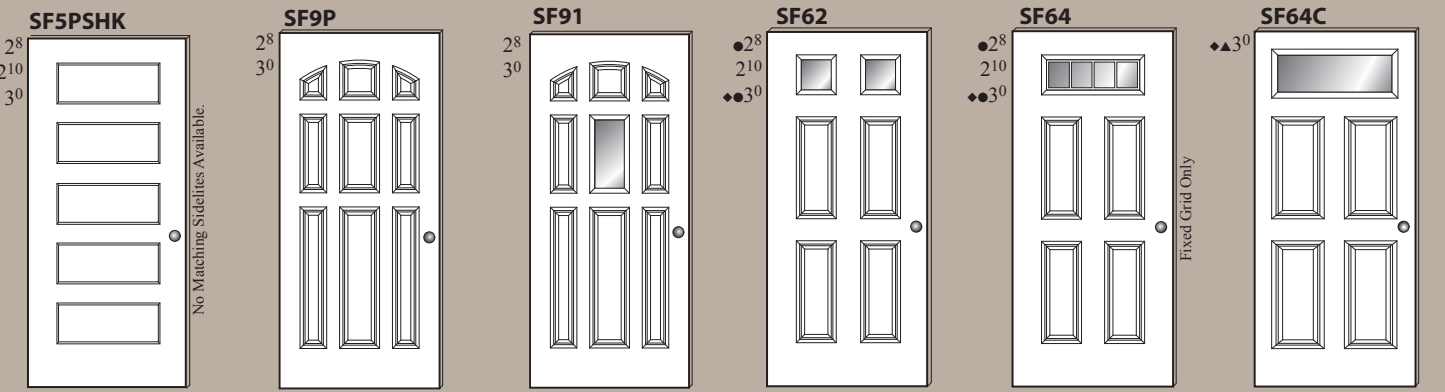

Color samples are reproduced as close as possible, actual color may vary.

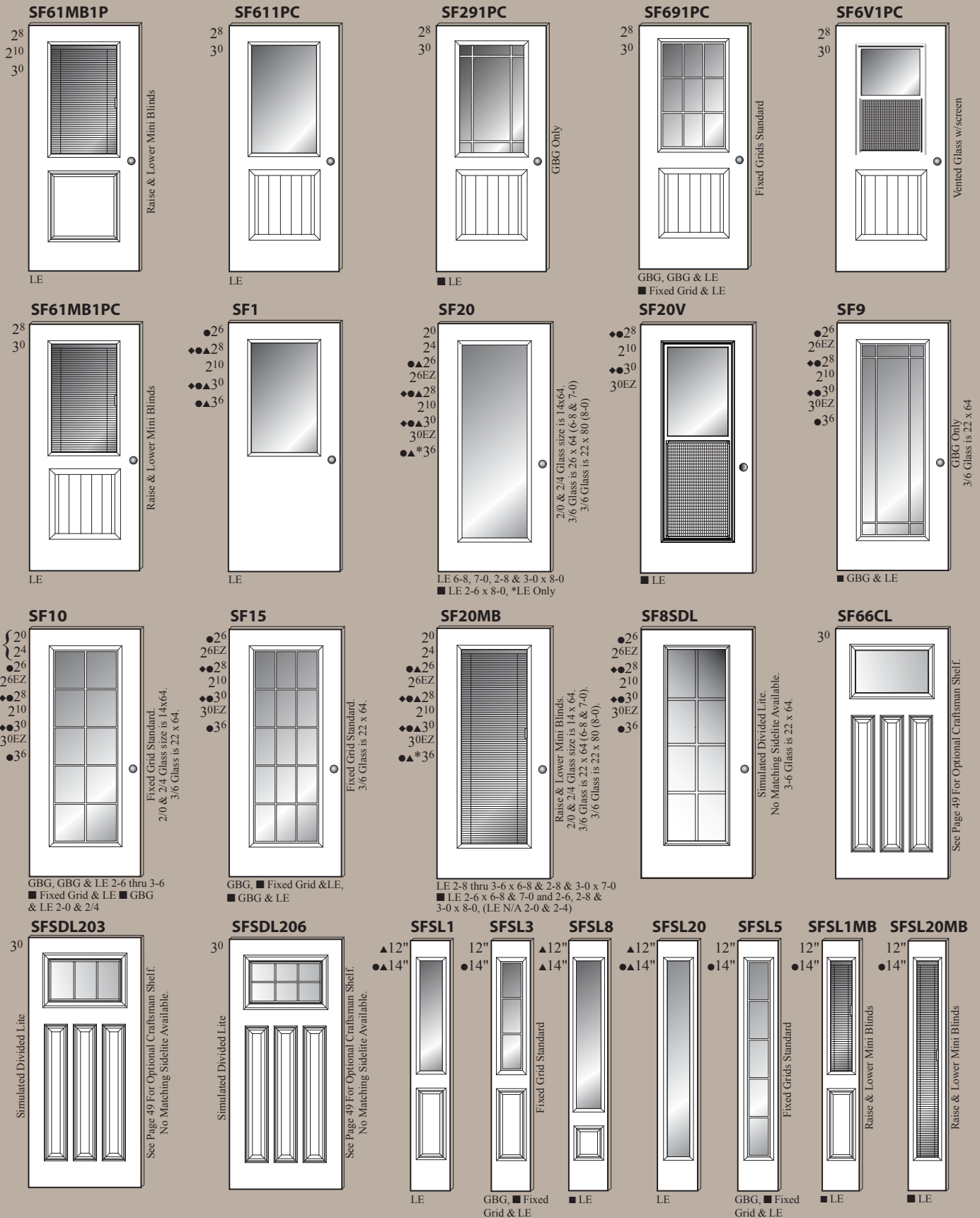

Color samples are reproduced as close as possible, actual color may vary.

## Smooth Fiberglass Flush-Glazed Collection



8/0 SF20F Flush-Glazed door.

### Key Code Chart

GBG ..... Available w/Grids Between Glass

LE ..... Available w/Low-E Glass

■ ..... Available w/Extended Leadtime.

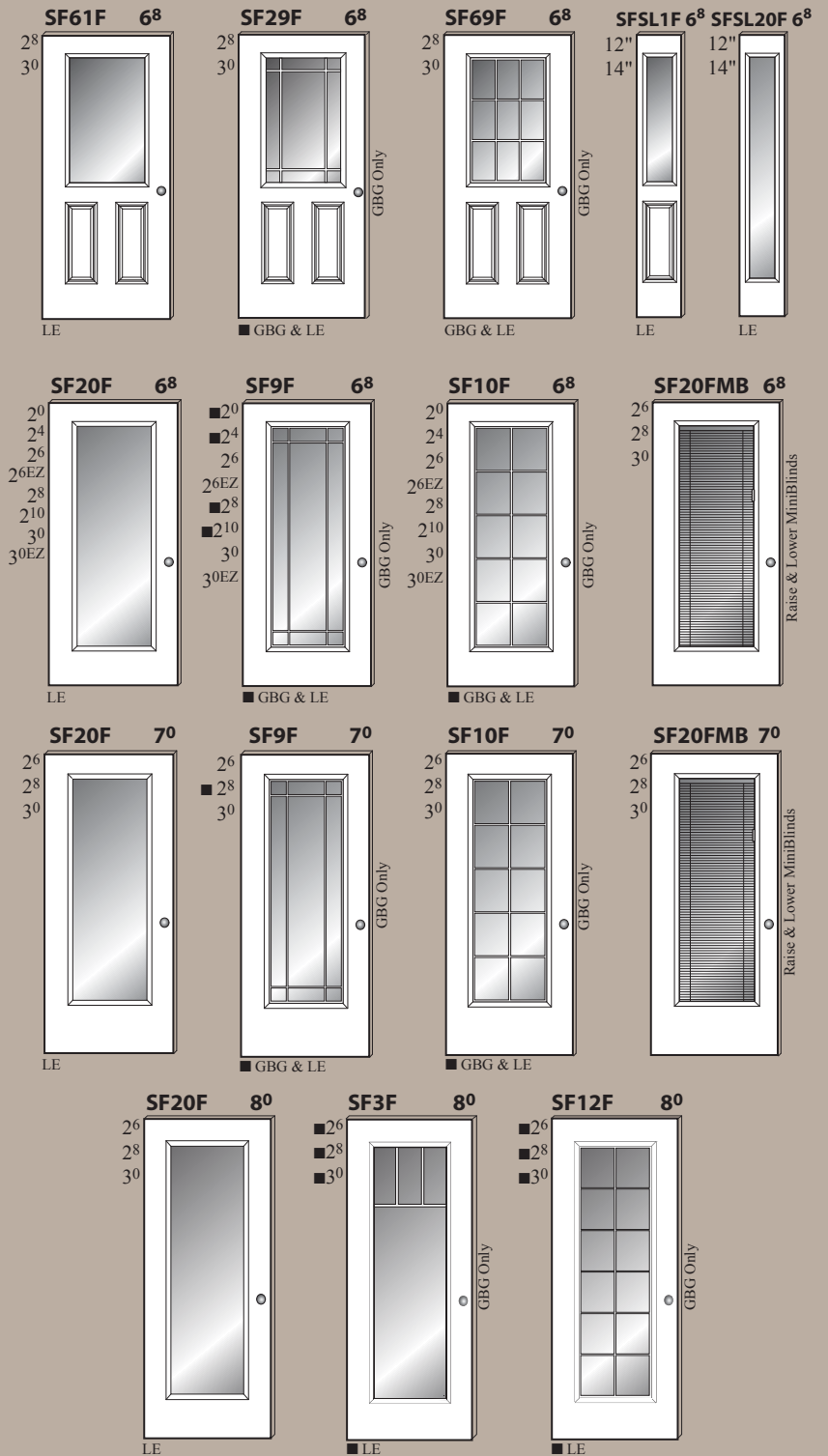

### Flush-Glazed Profile vs. Standard Lite Kit Profile

#### Flush-Glazed



#### Standard Lite Kit



**Smooth Fiberglass  
Flush-Glazed  
Contemporary  
Collection**

Our sleek aluminum Mullion Bars compliment the clean lines of our flush-glazed smooth fiberglass door. With 5 door styles and 4 glass options to choose from, you can create that unique entry you've been looking for.

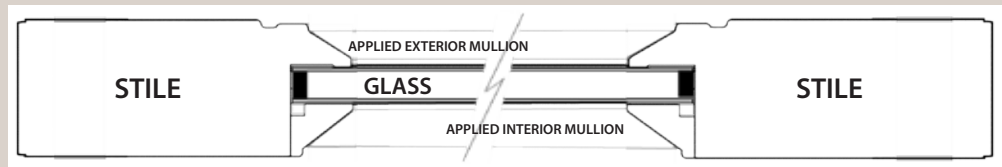
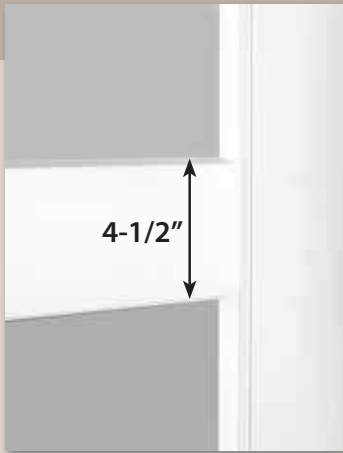

- Flush-Glazed Door Available in 6-8, 7-0, 8-0 & EZ-Fit Heights
- 4-1/2" Aluminum Mullion Bars Will Not Shrink
- Matching Sidelites Also Available
- 5/8" OA Glass ONLY

**STYLES**



SF20F2L



SF20F3L



SF20F4L

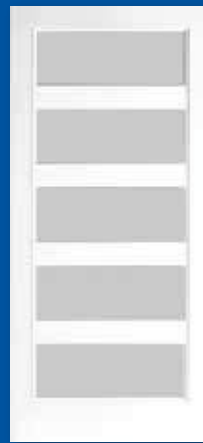

SF20F5L



SF20F3VL



SF5L20F3L



SF5L20F5L

**GLASS OPTIONS**



Clear & Low E



Satin Etch



Chord



Rooftop

\*Additional Glass Options Available, See Pages 36-37. Not Reglazeable!



*Smooth Fiberglass*

# Flush-Glazed Traditional Door & Sidelite Collection



Internal Shadow Bar (optional)

Applied SDL Bars

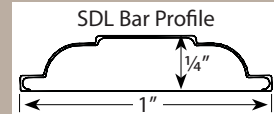

Flush-Glazed Bead

- Available in 6/8, 7/0 & 8/0 Heights
- Extended Leadtime Required
- For Glass Options See Pages 36-37

**CODEL**  
ENTRY SYSTEMS™

## OPTIONS

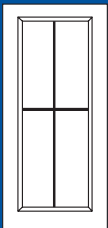

4L

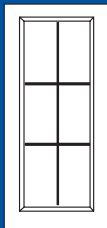

6L

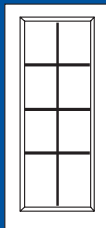

8L

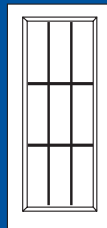

9L

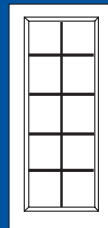

10L

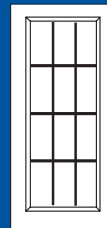

12L

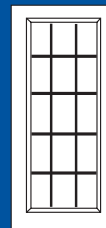

15L

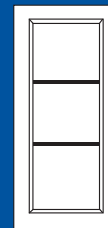

3LV

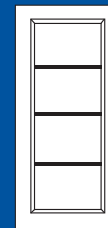

4LV

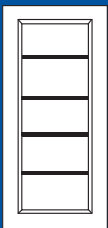

5LV

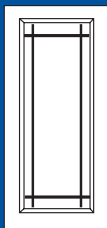

9LQA

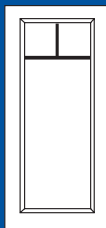

3LC

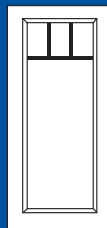

4LC

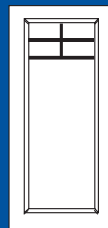

5LC

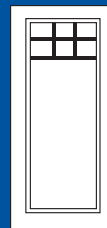

7LC



3SLV



4SLV



5SLV



6SLQA

## Oak Grain Textured Fiberglass Collection



TF8SDL door.

### Key Code Chart







GBG ..... Available w/Grids Between Glass

LE ..... Available w/Low-E Glass

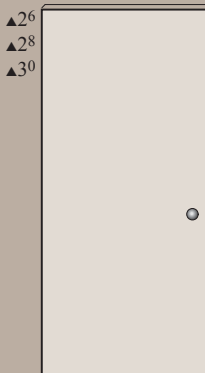
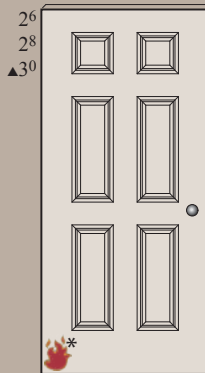
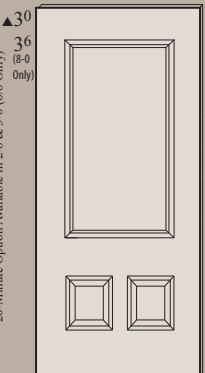
▲ ..... Available in 8<sup>0</sup> Height

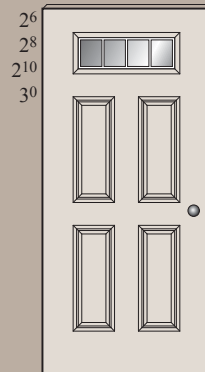
■ ..... Available w/Extended Leadtime.

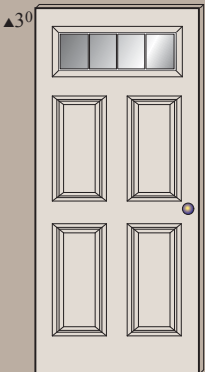
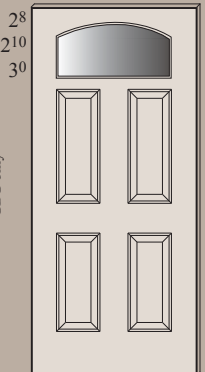
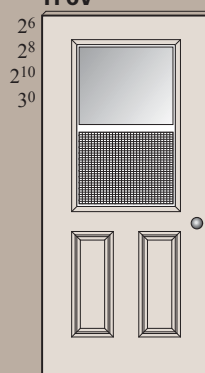
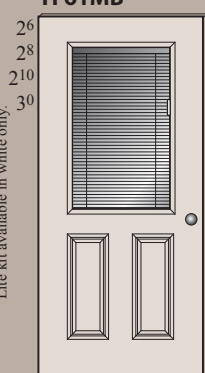
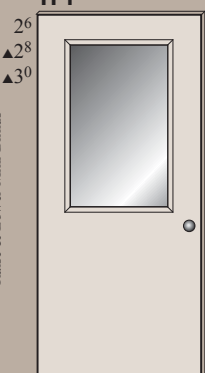
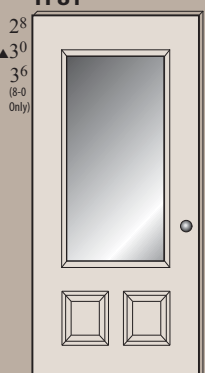
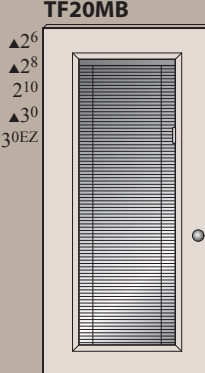
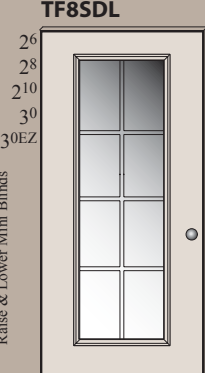
 ..... 20-Min. Fire Rated (6-8 Only)

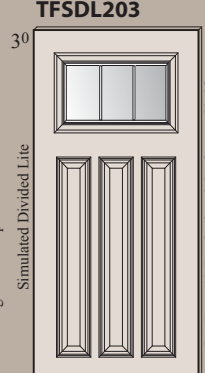
<p><b>TFF</b></p>  <p>▲26 ▲28 ▲30</p>	<p><b>TF6P/TF6P20</b></p>  <p>26 28 30 *20-Minute Option Available in 2-8 &amp; 3-0 (6-8 Only)</p>	<p><b>TF3P</b></p>  <p>▲30 36 (8-0 Only)</p>	<p><b>TF4P</b></p>  <p>▲30 8/0 Has Curved Top Panel</p>
<p><b>TF64</b></p>  <p>26 28 210 30 Fixed Grids Only</p>	<p><b>TF64C</b></p>  <p>▲30</p>	<p><b>TF64GBG</b></p>  <p>▲30 GBG only</p>	<p><b>TF648CL</b></p>  <p>28 210 30</p>
<p><b>TF6V</b></p>  <p>26 28 210 30 LE Vented Glass w/screen</p>	<p><b>TF61MB</b></p>  <p>26 28 210 30 Lite kit available in white only.</p>	<p><b>TF1</b></p>  <p>26 ▲28 ▲30 Raise &amp; Lower Mini Blinds</p>	<p><b>TF81</b></p>  <p>28 ▲30 36 (8-0 Only)</p>
<p><b>TF20MB</b></p>  <p>▲26 ▲28 210 30 30EZ Raise &amp; Lower Mini Blinds</p>	<p><b>TF8SDL</b></p>  <p>26 28 210 30 30EZ Simulated Divided Lite No Matching Sidelites Available</p>	<p><b>TF66CL</b></p>  <p>30 See Page 49 For Optional Craftsman Shelf</p>	<p><b>TFSDL203</b></p>  <p>30 Simulated Divided Lite</p>

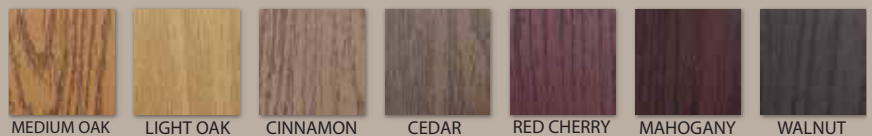

Color samples are reproduced as close as possible, actual color may vary.

See Page 49 For Optional Craftsman Shelf  
No Matching Sidelites Available



Color samples are reproduced as close as possible, actual color may vary.

# CODEL

ENTRY SYSTEMS™

## Oak Grain Textured Fiberglass Flush-Glazed Collection



6/8 TF20F Flush-Glazed door.

### Key Code Chart

GBG ..... Available w/Grids Between Glass

LE ..... Available w/Low-E Glass

■ ..... Available w/Extended Leadtime.

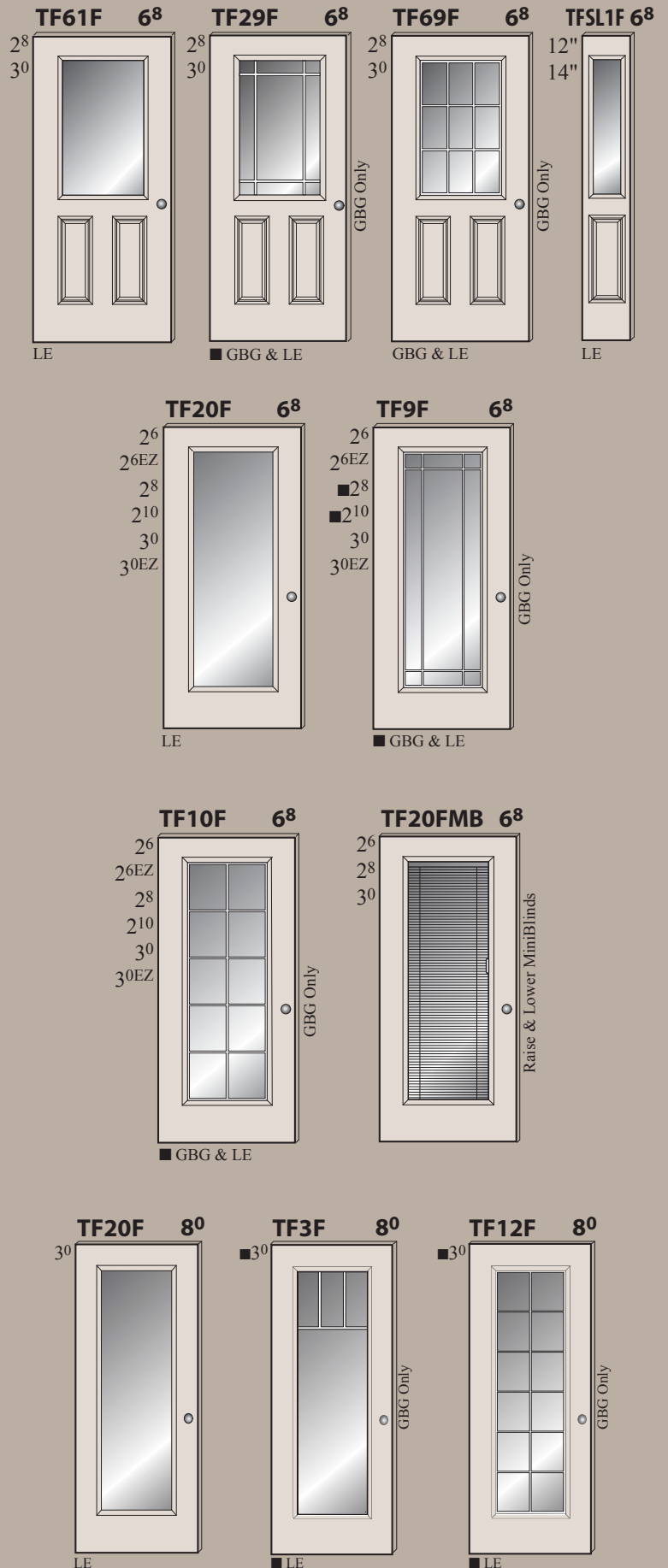

# Oak Grain Textured Fiberglass Flush-Glazed Traditional Door & Sidelite Collection



Internal Shadow Bar  
(optional)

Applied SDL Bars

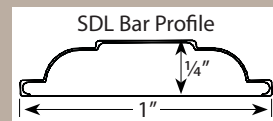

Flush-Glazed Bead

- Available in 6/8, 7/0 & 8/0 Heights
- Extended Leadtime Required
- For Glass Options See Pages 36-37

**CODEL**  
ENTRY SYSTEMS™

## OPTIONS



4L

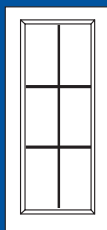

6L

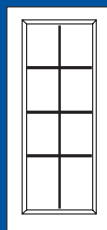

8L

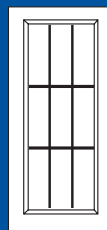

9L

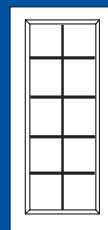

10L

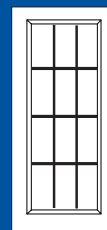

12L

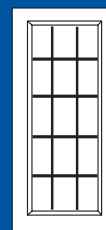

15L

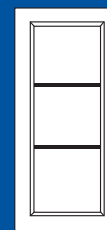

3LV

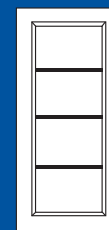

4LV

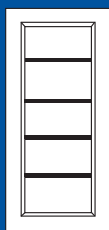

5LV

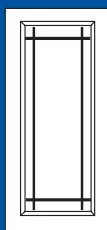

9LQA

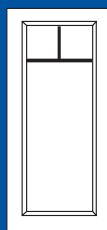

3LC

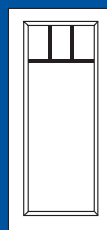

4LC



5LCS

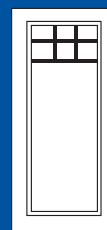

7LC



3SLV

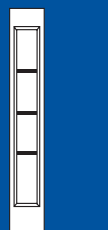

4SLV

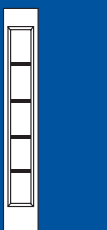

5SLV



6SLQA

# CODEL

ENTRY SYSTEMS™

## Fir Grain Textured Fiberglass Collection (6-8 ONLY)



FG811P

### Key Code Chart

GBG ..... Available w/Grids Between Glass

LE ..... Available w/Low-E Glass

▲ ..... Available in 8<sup>0</sup> Height

■ ..... Available w/Extended Leadtime

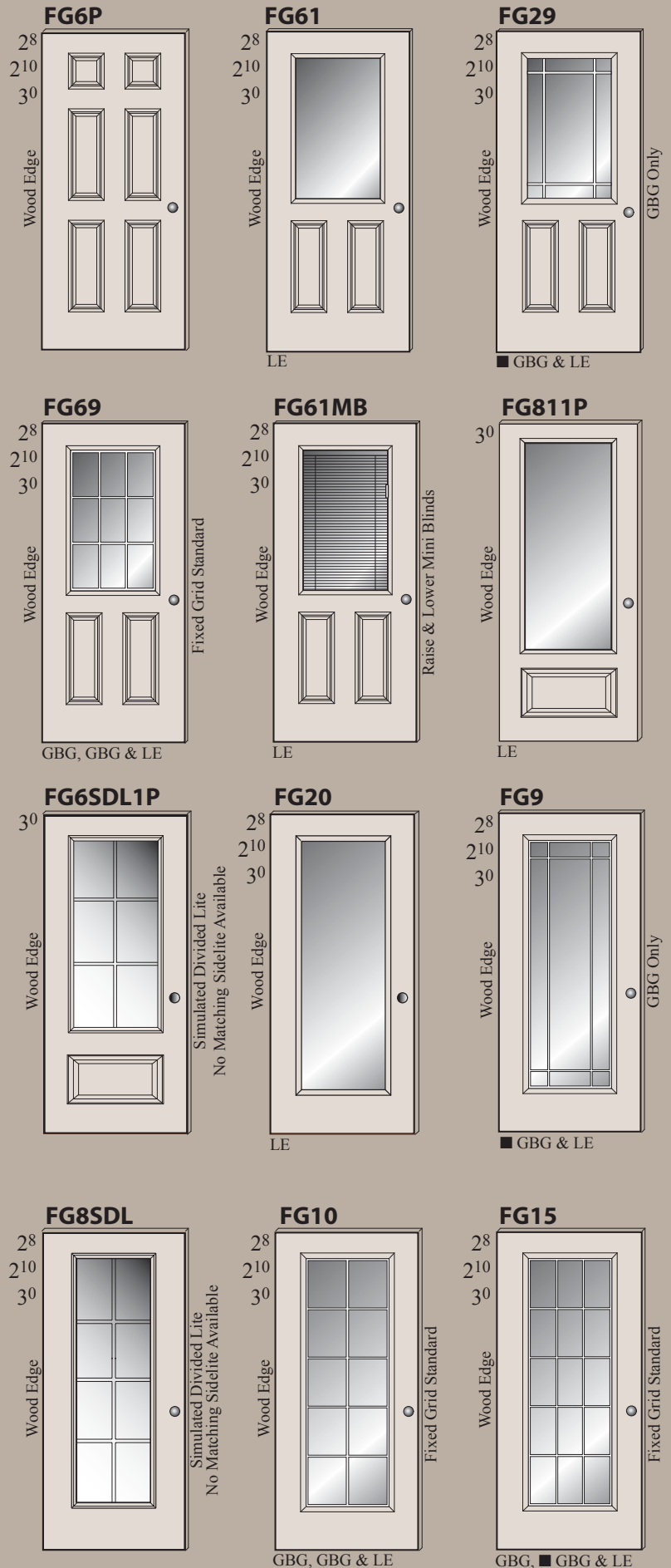

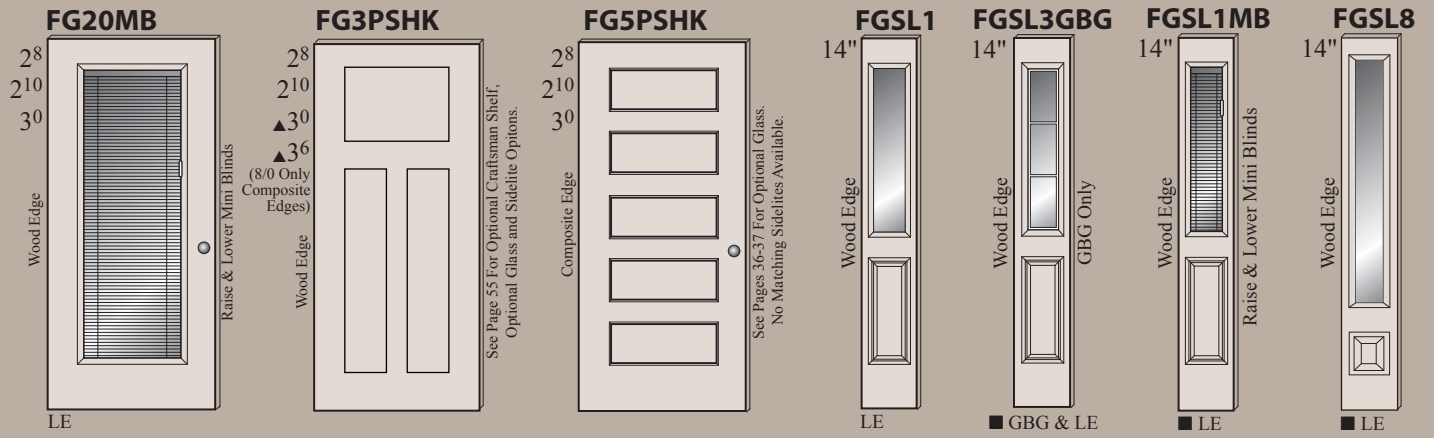

## Shaker Fiberglass Collection



FG3PSHK door.

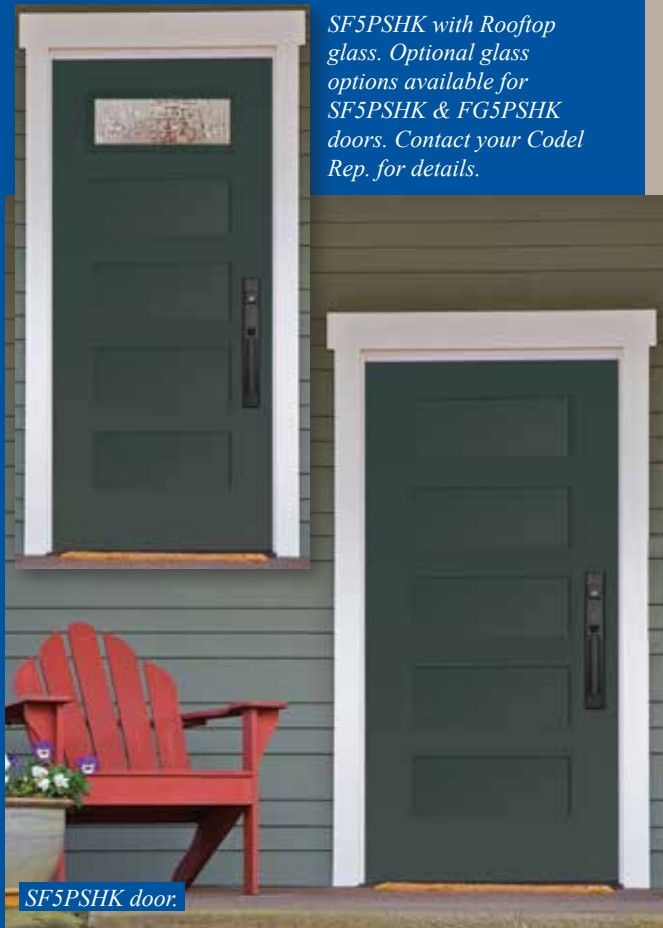

SF5PSHK door.

SF5PSHK with Rooftop glass. Optional glass options available for SF5PSHK & FG5PSHK doors. Contact your Codel Rep. for details.

SF3PSHK  
SF3PSHK80

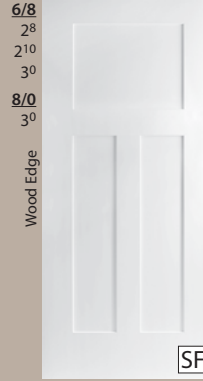

Optional C-21 Craftsman Shelf Available.  
See Pages 51 & 53.

SFHER201  
SFHER301



SFHER260  
SFHER280



FG3PSHK  
FG3PSHK80



Optional C-21 Craftsman Shelf Available.  
See Pages 55 & 57.

FGHER201  
FGHER301



FGHER260  
FGHER280



SF3PSHK80



No Matching Sidelite Available.  
No Craftsman Shelf Available.

FG3PSHK80



No Matching Sidelite Available.  
No Craftsman Shelf Available.

Optional Glass

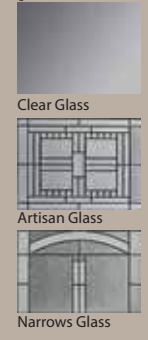

3/6 Craftsman Lite Kit Profile

SF5PSHK



No Matching Sidelite Available

FG5PSHK



No Matching Sidelite Available



*"True White"*  
**Oak Grain Textured  
 Fiberglass Collection**



TW6P door.

**Key Code Chart**

GBG ..... Available w/Grids Between Glass

LE ..... Available w/Low-E Glass

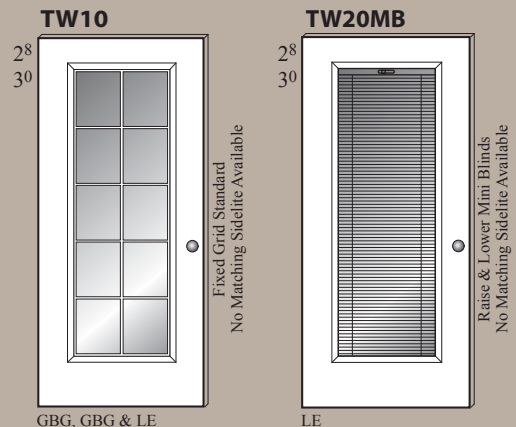
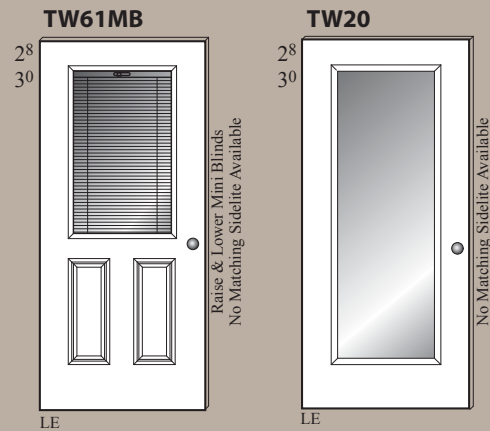
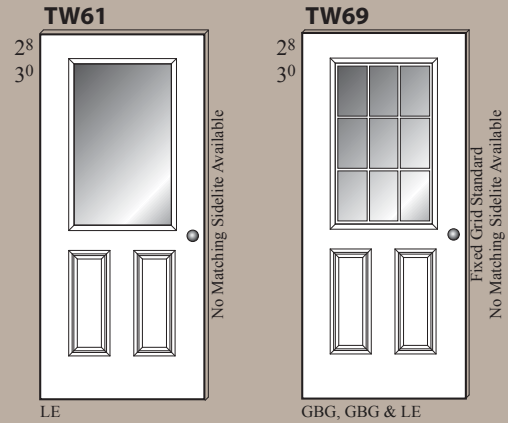
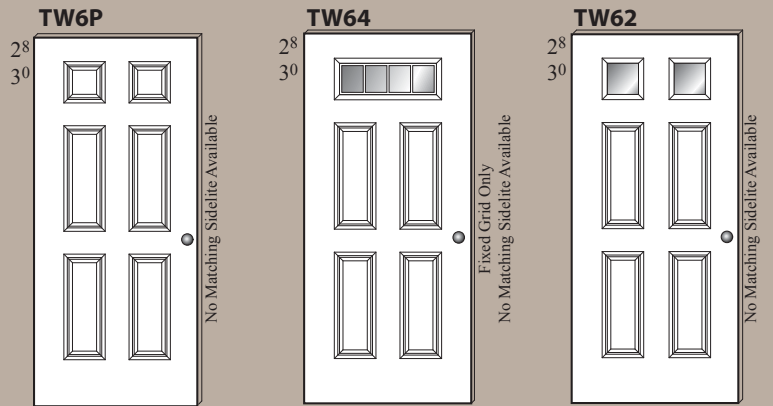

# SINGLE-HINGED INSWING FIBERGLASS PATIO DOOR

The Single-Hinged Inswing Patio door provides the look of a double door, with the functionality of a single door. The “one-door-fixed/one-door-operable” configuration comes standard with a sliding screen, and is perfect for areas where interior space is limited. Available in a variety of sizes ranging from standard to retro-fit (EZ-Fit), the Single-Hinged Inswing Patio door is a great choice for new construction and remodel projects, alike.

*(Outswing option also available with no sliding screen)*

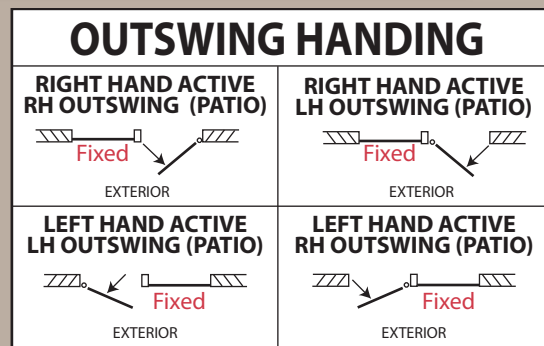
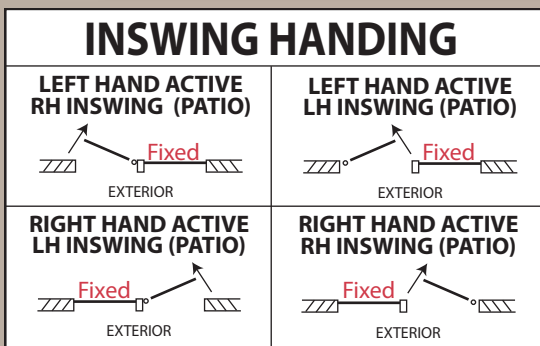

*\*Screen not available on outswings.*

**Standard 6-8 Patio Sizes (SP)**

**EZ-Fit (Retro) Patio Sizes (EZP)**

**20F/20**

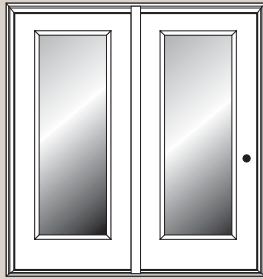

Clear/Low-E

SF  
TF

FLUSH-GLAZED SIZES	LITE KIT SIZES
<b>SF20FSP</b>	<b>SF20SP</b>
5-0 x 6-8	5-0 x 6-8
5-4 x 6-8	5-4 x 6-8
5-8 x 6-8	5-8 x 6-8
6-0 x 6-8	6-0 x 6-8
<b>TF20FSP</b>	<b>TF20SP</b>
5-0 x 6-8	5-0 x 6-8
5-4 x 6-8	5-4 x 6-8
5-8 x 6-8	5-8 x 6-8
6-0 x 6-8	6-0 x 6-8

FLUSH-GLAZED SIZES	LITE KIT SIZES
<b>SF20FEZP</b>	<b>SF20EZP</b>
5-0 x EZ	5-0 x EZ
6-0 x EZ	6-0 x EZ
<b>TF20FEZP</b>	<b>TF20EZP</b>
5-0 x EZ	6-0 x EZ
6-0 x EZ	

**10F/10**

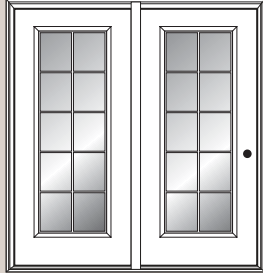

10 Lite Fixed or GBG

SF  
TF

FLUSH-GLAZED SIZES	LITE KIT SIZES
<b>SF10FSP</b>	<b>SF10SP</b>
5-0 x 6-8	5-0 x 6-8
5-4 x 6-8	5-4 x 6-8
5-8 x 6-8	5-8 x 6-8
6-0 x 6-8	6-0 x 6-8
<b>TF10FSP</b>	<b>TF10SP</b>
5-0 x 6-8	5-0 x 6-8
5-4 x 6-8	5-4 x 6-8
5-8 x 6-8	5-8 x 6-8
6-0 x 6-8	6-0 x 6-8

FLUSH-GLAZED SIZES	LITE KIT SIZES
<b>SF10FEZP</b>	<b>SF10EZP</b>
5-0 x EZ	5-0 x EZ
6-0 x EZ	6-0 x EZ
<b>TF10FEZP</b>	<b>TF10EZP</b>
5-0 x EZ	6-0 x EZ
6-0 x EZ	

**9F/9**

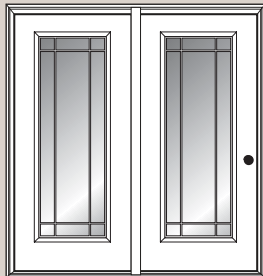

9 Lite Marginal, GBG Only

SF  
TF

FLUSH-GLAZED SIZES	LITE KIT SIZES
<b>SF9FSP</b>	<b>SF9SP</b>
5-0 x 6-8	5-0 x 6-8
5-4 x 6-8	5-4 x 6-8
5-8 x 6-8	5-8 x 6-8
6-0 x 6-8	6-0 x 6-8
<b>TF9FSP</b>	<b>TF9SP</b>
5-0 x 6-8	5-0 x 6-8
5-4 x 6-8	5-4 x 6-8
5-8 x 6-8	5-8 x 6-8
6-0 x 6-8	6-0 x 6-8

FLUSH-GLAZED SIZES	LITE KIT SIZES
<b>SF9FEZP</b>	<b>SF9EZP</b>
5-0 x EZ	5-0 x EZ
6-0 x EZ	6-0 x EZ
<b>TF9FEZP</b>	<b>TF9EZP</b>
5-0 x EZ	6-0 x EZ
6-0 x EZ	

**20FMB/20MB**



Miniblinds

SF  
TF

FLUSH-GLAZED SIZES	LITE KIT SIZES
<b>SF20FMBSP</b>	<b>SF20MBSP</b>
5-0 x 6-8	5-0 x 6-8
5-4 x 6-8	5-4 x 6-8
6-0 x 6-8	5-8 x 6-8
	6-0 x 6-8
<b>TF20FMBSP</b>	<b>TF20MBSP</b>
5-0 x 6-8	5-0 x 6-8
5-4 x 6-8	5-4 x 6-8
6-0 x 6-8	5-8 x 6-8
	6-0 x 6-8

LITE KIT SIZES (ONLY)
<b>SF20MBEZP</b>
5-0 x EZ
6-0 x EZ
<b>TF20MBEZP</b>
6-0 x EZ

**20V**



Vented w/Screen  
Lite Kit Available in White Only

SF  
TF

LITE KIT SIZES
<b>SF20VSP</b>
5-4 x 6-8
5-8 x 6-8
6-0 x 6-8
<b>TF20VSP</b>
5-4 x 6-8
5-8 x 6-8
6-0 x 6-8

LITE KIT SIZES (ONLY)
<b>SF20VEZP</b>
6-0 x EZ
<b>TF20VEZP</b>
6-0 x EZ



	NET UNIT WIDTH	INSWING ADJ. SILL	OUTSWING BUMPER SILL
5-0 x 6-8	62-1/2"	81-3/4"	80-1/2"
5-4 x 6-8	66-1/2"	81-3/4"	80-1/2"
5-8 x 6-8	70-1/2"	81-3/4"	80-1/2"
6-0 x 6-8	74-1/2"	81-3/4"	80-1/2"

	NET UNIT WIDTH	INSWING ADJ. SILL	OUTSWING BUMPER SILL
5-0 x EZ-FIT	59-1/2"	79-1/2"	78-3/4"
6-0 x EZ-FIT	71-1/2"	79-1/2"	78-3/4"

\*Screen not available on outswings.

\*Screen not available on outswings.

# OBSCURE GLASS OPTIONS



**Clear or Low-E**



**Bubble**



**Chord**

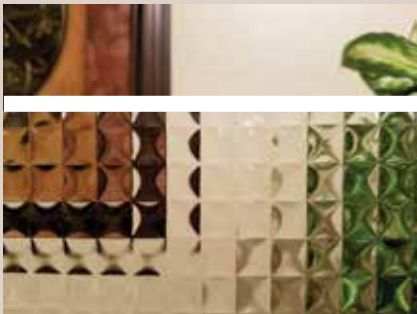

**Cross Reed**



**Delta Frost**



**Glue Chip**



**Large Leaf**



**Mistlite**



**Monumental**



**Narrow Reed**

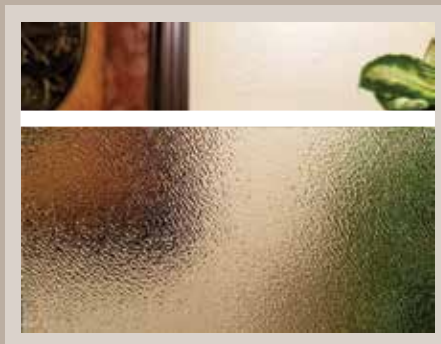

**Pinhead**

# OBSCURE GLASS OPTIONS



**Quattro**



**Rain**



**Rooftop**



**Sable**



**Satin Etch**

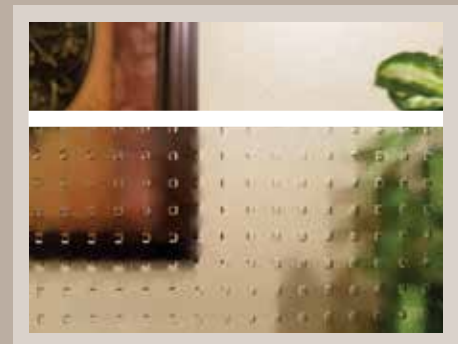

**Screen Dot**

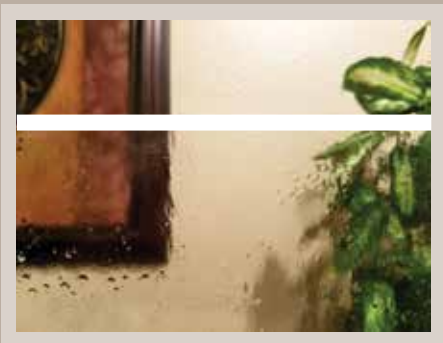

**Sea Spray**

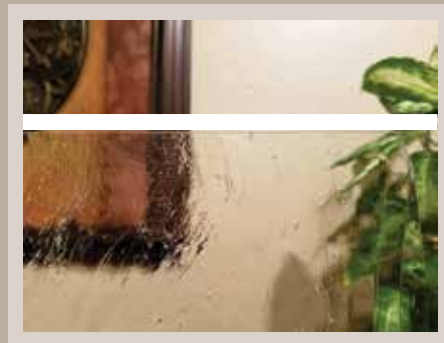

**Seedy Baroque**



**Small Leaf**

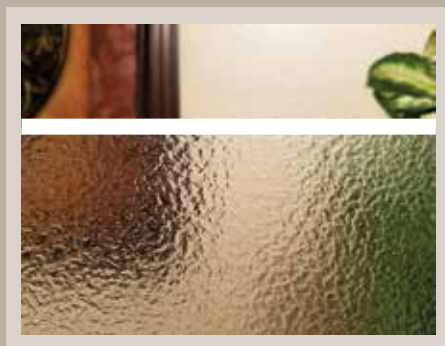

**Travertine**

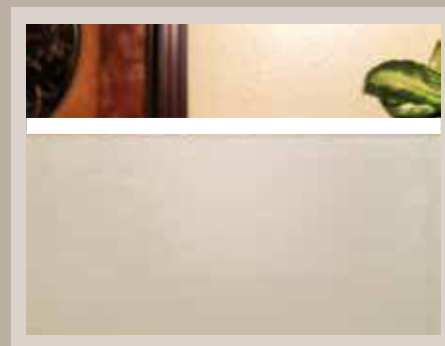

**White Laminate**

*\*Extended leadtime required. Due to available sheet sizes  
check with Codel Representative for availability.*

**CODEL**  
ENTRY SYSTEMS™

**Steel Door  
Collection** (6/8 ONLY)



LIMITED  
**5**  
YEAR  
WARRANTY



Steel CF10 door.

**STEEL DOORS**

The wood-edge steel door series is a popular choice for new construction as well as remodeling projects.

The versatility and thermal advantages of a wood-edge door are combined with the durability of 24-gauge steel facings. Units are permanently held in place by the adhesion of the polyurethane core.

After assembly, doors are primed for superior corrosion resistance. Wood-edge steel doors are available with a \*20-minute fire rating for all 6'8" doors up to 3'0" wide. (\*Excludes doors w/lite kits.)

**Thermal Performance values established in accordance with the International Energy Conservation Code (IECC) section 102.3**

	R value	U value	SHGC value
Steel door unit without Glass	6.25	0.16	0.00
Steel door unit with 1/4 Clear Glass	5.00	0.20	0.08
Steel door unit with 1/2 Clear Glass	3.85	0.26	0.19
Steel door unit with Full Clear Glass	2.78	0.36	0.34
Steel door unit with 1/2 LowE Glass	4.55	0.22	0.16
Steel door unit with Full LowE Glass	3.57	0.28	0.28
Steel door unit with 1/4 Decorative Glass	5.55	0.18	0.07
Steel door unit with 1/2 Decorative Glass	4.16	0.24	0.15
Steel door unit with 3/4 Decorative Glass	4.17	0.24	0.20
Steel door unit with Full Decorative Glass	3.45	0.29	0.27

**Key Code Chart**

GBG ..... Available w/Grids between Glass

LE ..... Available w/Low-E Glass

■ ..... Extended Leadtime Required

🔥 ..... 20-Min. Fire Rated (\*6-8 Only, 3-0 Max Width.)



***FAST-FRAME™***

***Introducing the Ultimate in Adjustable Steel Door Frames***

FAST-FRAME'S advanced design adds a new dimension of flexibility and durability to Codel's steel entry door line. FAST-FRAME™ features closure kits with full 1" of adjustability to accommodate almost any variation in wall construction. This easy-to-install, user-friendly, kerfed steel door frame system is applicable to a full range of residential and commercial applications - wood or steel stud construction. FAST FRAME is engineered to meet the most stringent code requirements including structural, impact and 90-minute fire ratings.



C690 door.

Adjustable T-Strike  
1/4" of adjustment allows for ease of field installations for proper door closure

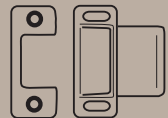

Closure Span Adjustment Chart

Wall Sizes
4 1/2" - 5 1/2"
5 1/2" - 6 1/2"
6 1/2" - 7 1/2"
7 1/2" - 8 1/2"
8 1/2" - 9 1/2"
9 1/2" - 10 1/2"

Weatherstripping  
Schlegal foam-filled  
compression (QEBD500)  
90 Min. Fire Rating

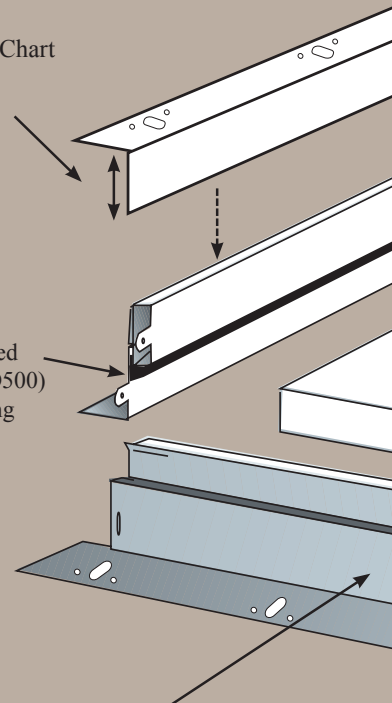

Prime Bright White EG  
Galvanized 20-gauge steel to provide superior corrosion resistance and an optimal surface for painting

**APPLICATIONS**

- Multi-Family ● Assisted Living ● Motel/Hotel ● House to Garage ● Garage to Exterior



**FIRE LABELS**

90 Minute Fire Rating - up to 3'0" x 6'8".

**CLOSURE TEST** In a 90-minute application, the door will close and latch from 18" if the following Fast-Frame components are used:

- QEBD500 Foam-Filled Compression Weatherstripping
- Factory Sweep ● Adjustable T-Strike ● Factory Supplied Sills



**STRUCTURAL PERFORMANCE AND IMPACT RATING**

Design pressure ratings are available for compliance with national, state and local wind load and/or missile requirements. Product approval under the Miami-Dade BCCO NOA or Intertek Testing Services/Warnock Hersey® programs.



# Door Handing

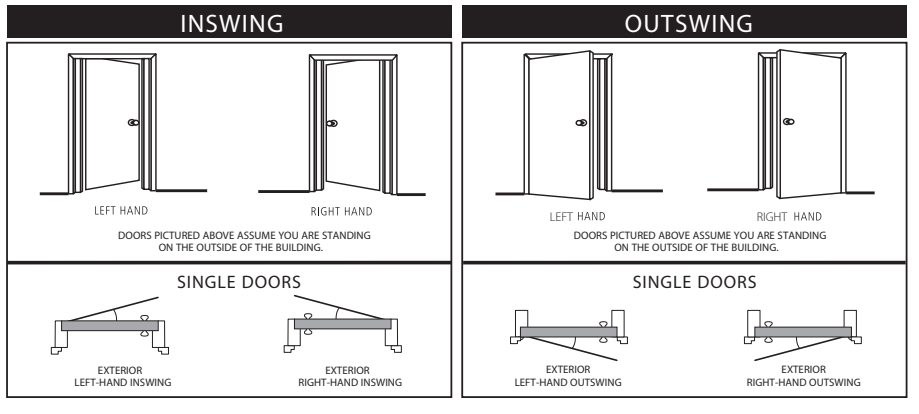

**SILLS**  
 Standard Inswing  
 Thermally broken - 5 5/8" width  
 Optional extenders for larger wall sizes  
 Note: Not for use on outswing applications.



**Handicap (ADA)**  
 Double Slope 4-9/16" & 6-9/16" width



**Tile Face** 4-1/4" and 6-1/4"



■ \*Extended Lead Time

**Bumper Outswing** 4-9/16" width (ONLY)

■ \*Extended Lead Time

Outer Adjustable Closure  
 20-gauge Steel  
 2 uprights - 1 header

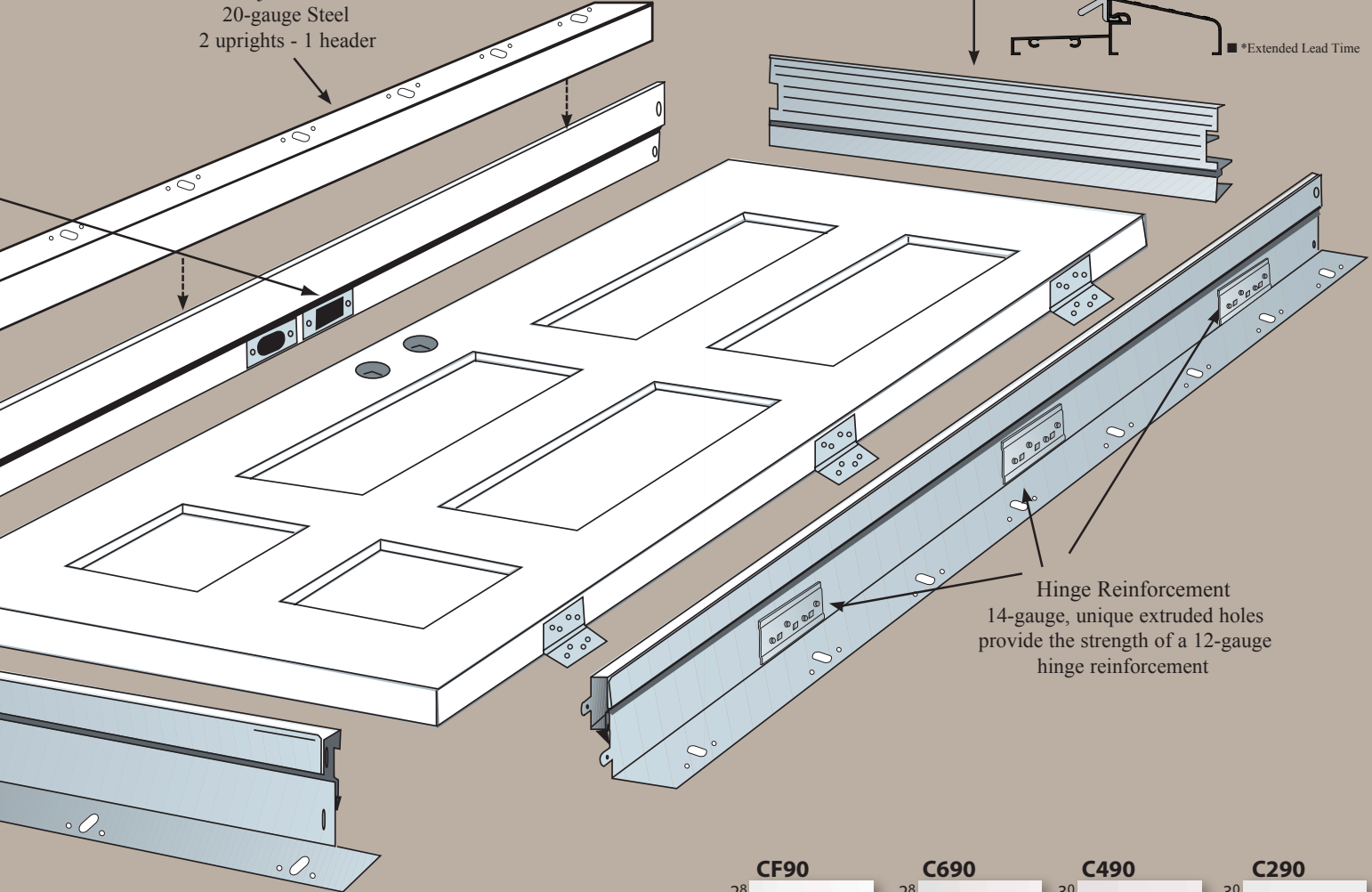

**Hinge Reinforcement**  
 14-gauge, unique extruded holes provide the strength of a 12-gauge hinge reinforcement

Prehung Door Sizes	Nominal Door Size	Rough Opening Size (wood stud)
	Width x Height	Width x Height
Single Door	2'8" x 6'8"	33-1/4" x 81-3/8"
	3'0" x 6'8"	37-1/4" x 81-3/8"
	3'0" x 7'0"	37-1/4" x 85-3/8"



-All dimensions shown are for doors with standard inswing sill.  
 Deduct 13/16" for bumper outswing or handicap compliant sill.

■ Extended Leadtime Required. 🔥 90-Minute Fire-Rated.

\*Available in 7/0



**6/8 & 7/0  
Contemporary  
Classics**  
*Smooth Fiberglass (Only)*

Contemporary Classics CON-2285.



Daylight Glass Size 21" x 2-1/2"

SF

CON-2235  
6-8 (28 210 30 36)  
7-0 (28 30 36)



Daylight Glass Size 21" x 7"

SF

CON-2285  
6-8 (28 210 30 36)  
7-0 (28 30 36)



Daylight Glass Size 6" x 63"

SF

CON-764S  
6-8 (28 210 30 36)  
7-0 (28 30 36)



Daylight Glass Size 6" x 63"

SF

CON-764SL  
(12" & 14")



Daylight Glass Size 7" x 7"

SF

CON-865S  
6-8 (28 210 30 36)  
7-0 (28 30 36)



Daylight Glass Size 7" x 7"

SF

CON-865SL  
(14")

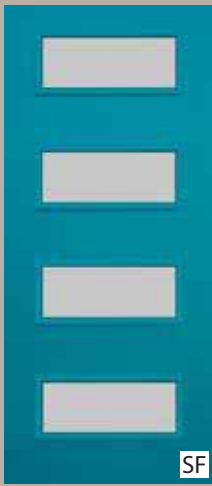

Daylight Glass Size 21" x 7"

SF

CON-2284  
6-8 (28 210 30 36)  
7-0 (28 30 36)

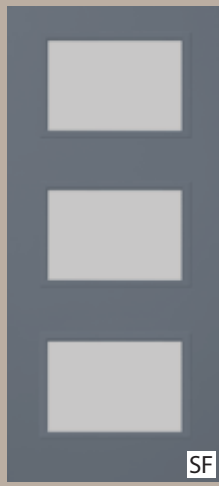

Daylight Glass Size 21" x 14-1/4"

SF

CON-22153  
6-8 (28 210 30 36)  
7-0 (28 30 36)

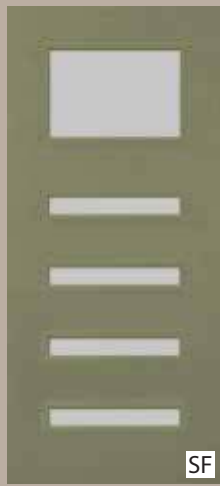

Daylight Glass Size 21" x 2-1/2" (4) & 21-1/4" (1)

SF

CON-221534  
6-8 (28 210 30 36)  
7-0 (28 30 36)



Daylight Glass Size 6" x 63" (x 2)

SF

CON-7642  
6-8 (28 210 30 36)  
7-0 (28 30 36)

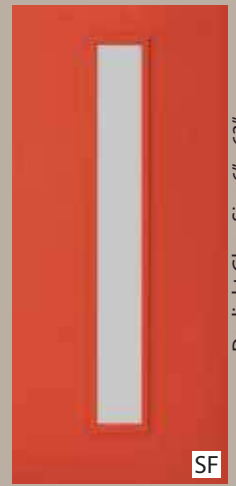

Daylight Glass Size 6" x 63"

SF

CON-764C  
6-8 (28 210 30 36)  
7-0 (28 30 36)



Daylight Glass Size 7" x 7"

SF

CON-884C  
6-8 (28 210 30 36)  
7-0 (28 30 36)



Daylight Glass Size 7" x 7"

SF

CON-884S  
6-8 (28 210 30 36)  
7-0 (28 30 36)



Daylight Glass Size 7" x 7"

SF

CON-884SL  
(14")

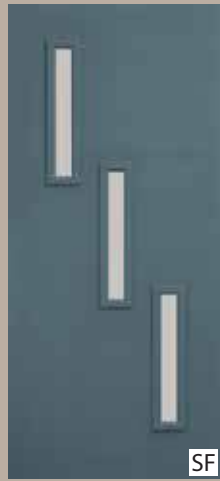

Daylight Glass Size 2-1/2" x 21"

SF

CON-3223  
6-8 (28 210 30 36)  
7-0 (28 30 36)



Daylight Glass Size 7" x 7"

SF

CON-884D  
6-8 (28 210 30 36)  
7-0 (28 30 36)

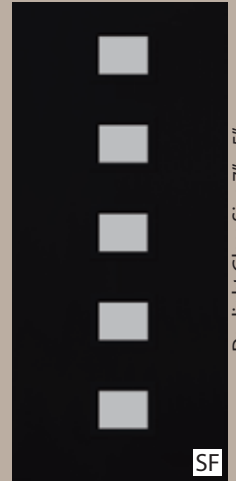

Daylight Glass Size 7" x 5"

SF

CON-865C  
6-8 (28 210 30 36)  
7-0 (28 30 36)

## Stock Glass Options



Clear/LowE

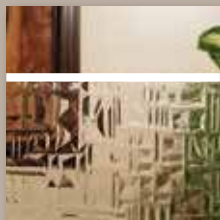

Rooftop

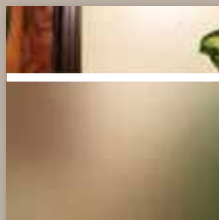

Satin Etch

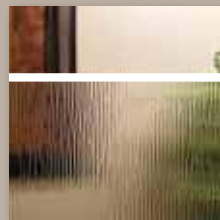

Chord

\*Additional Glass Options Available, See Pages 36-37.

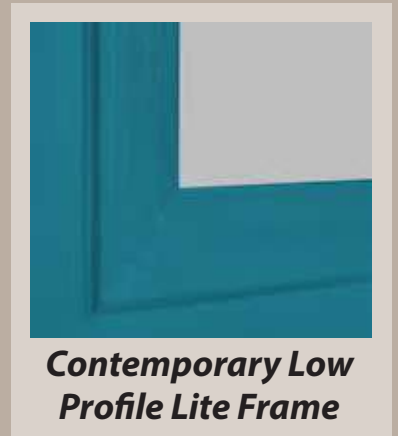

**Contemporary Low Profile Lite Frame**



SF Smooth Fiberglass

Color samples are reproduced as close as possible, actual color may vary.



8/0  
**Contemporary Classics**  
*Smooth Fiberglass (Only)*

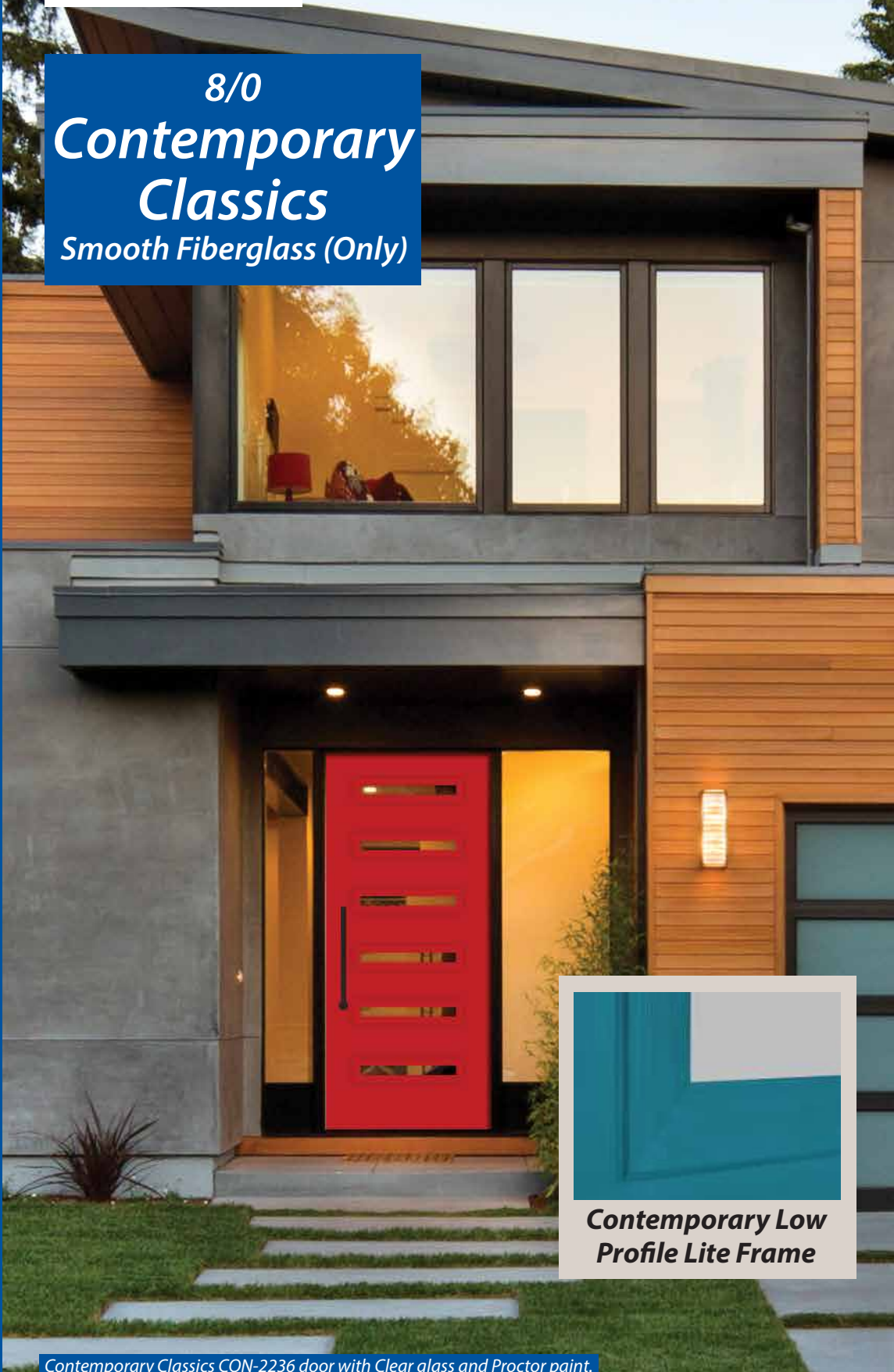

**Contemporary Low Profile Lite Frame**

*Contemporary Classics CON-2236 door with Clear glass and Proctor paint.*



Daylight Glass Size 21" x 2-1/2"

CON-2236  
(28 30 36)

SF

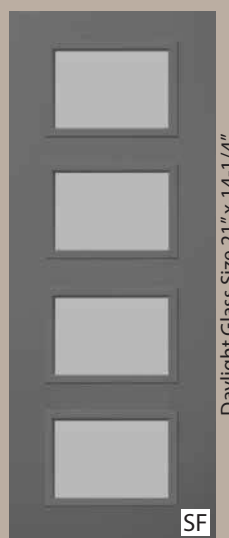

Daylight Glass Size 21" x 14-1/4"

CON-22154  
(28 30 36)

SF



Daylight Glass Size 7" x 5"

CON-866C  
(28 30 36)

SF

# Stock Glass Options



Daylight Glass Size 21" x 7"

SF

CON-2286  
(28 30 36)



Daylight Glass Size 21" x 7"

SF

CON-2285  
(28 30 36)

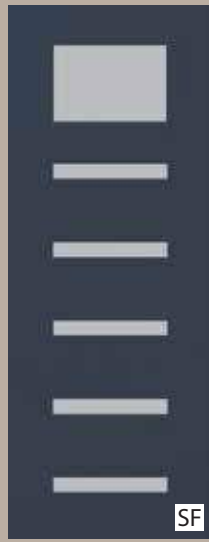

Daylight Glass Size 21" x 2-1/2" (4) & 21-1/4" (1)

SF

CON-221535  
(28 30 36)

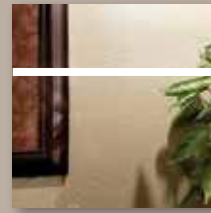

Clear/LowE

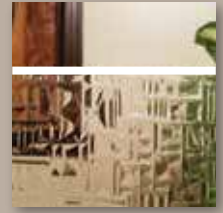

Rooftop

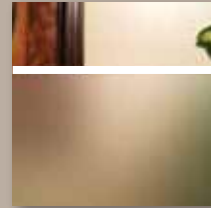

Satin Etch

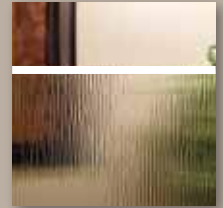

Chord

\*Additional Glass Options Available, See Pages 36-37.



Daylight Glass Size 7" x 7"

SF

CON-885C  
(28 30 36)



Daylight Glass Size 7" x 7"

SF

CON-885S  
(28 30 36)



Daylight Glass Size 7" x 7"

SF

CON-885SL  
(14")



Daylight Glass Size 7" x 5"

SF

CON-866S  
(28 30 36)



Daylight Glass Size 7" x 5"

SF

CON-866SL  
(14")



Daylight Glass Size 7" x 7"

SF

CON-885D  
(28 30 36)

DAFFODIL	FREMONT	RAVENA
PROCTOR	COUGAR	TOMATO
BURGUNDY	HUNTER	MAGNOLIA
ARTICHOKE	NAVY	PACIFIC
BALLARD	DENIM	CARBON
IRON	FLINT	CONCRETE
ESPRESSO	TRUFFLE	TAUPE
SAND	BRIGHT	IVORY

SF Smooth Fiberglass

Color samples are reproduced as close as possible, actual color may vary.

# Smooth Fiberglass Decorative Contemporary Classics

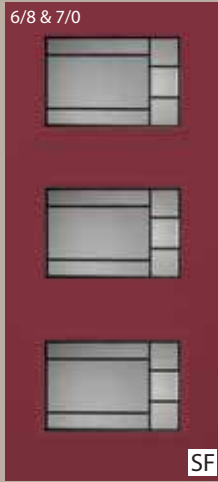
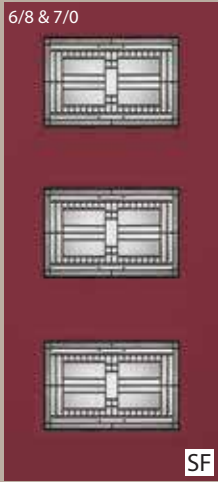

ART-22153  
6-8 (28 210 30 36)  
7-0 (28 30 36)

MOD-22153  
6-8 (28 210 30 36)  
7-0 (28 30 36)

HAR-22153  
6-8 (28 210 30 36)  
7-0 (28 30 36)

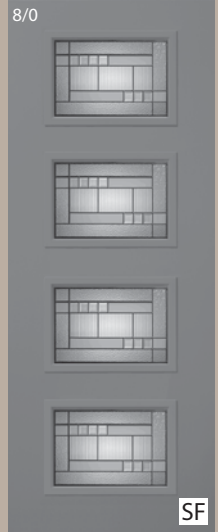
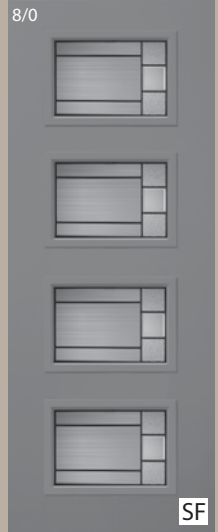
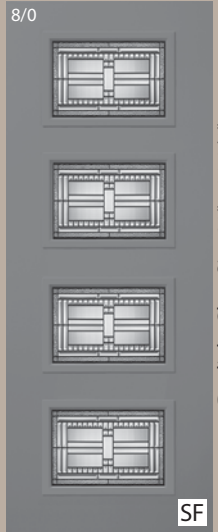

ART-22154  
(28 30 36)

MOD-22154  
(28 30 36)

HAR-22154  
(28 30 36)

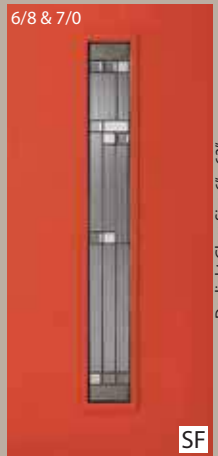
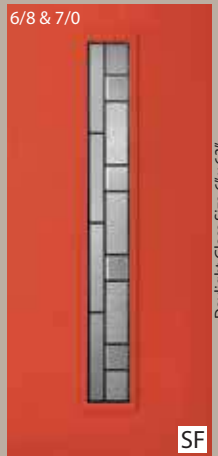
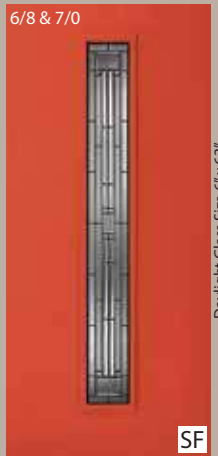
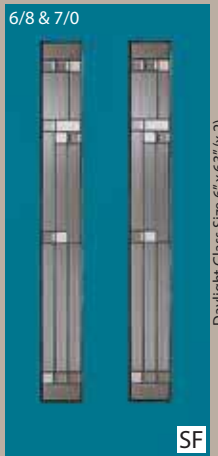
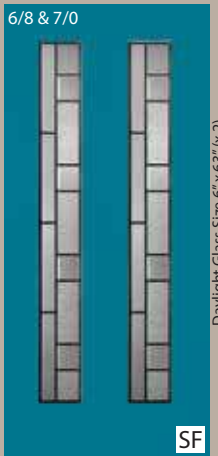
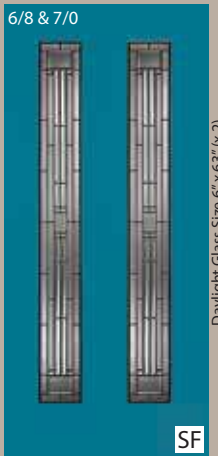
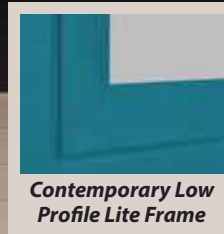

ART-7642  
6-8 (28 210 30 36)  
7-0 (28 30 36)

MOD-7642  
6-8 (28 210 30 36)  
7-0 (28 30 36)

HAR-7642  
6-8 (28 210 30 36)  
7-0 (28 30 36)

ART-764C  
6-8 (28 210 30 36)  
7-0 (28 30 36)

MOD-764C  
6-8 (28 210 30 36)  
7-0 (28 30 36)

HAR-764C  
6-8 (28 210 30 36)  
7-0 (28 30 36)



Color samples are reproduced as close as possible, actual color may vary.

# Smooth Fiberglass Decorative Contemporary Classics



ART-764S  
6-8 (28 210 30 36)  
7-0 (28 30 36)



MOD-764S  
6-8 (28 210 30 36)  
7-0 (28 30 36)

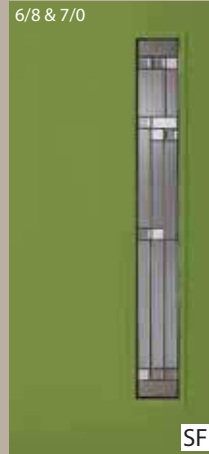

HAR-764S  
6-8 (28 210 30 36)  
7-0 (28 30 36)



ART-764SL  
(12" & 14")



MOD-764SL  
(12" & 14")

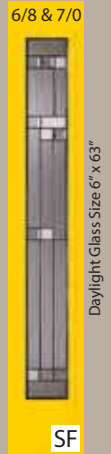

HAR-764SL  
(12" & 14")

# 6" Teak Grain Textured Fiberglass Door



Light Oak



Medium Oak



Cinnamon



Cedar



Red Cherry



Mahogany



Walnut



Unfinished



TFT 3-0 x 6-8



Color samples are reproduced as close as possible, actual color may vary.



# 6<sup>8</sup> Standard Craftsman

Adelaide ADE-200 door.

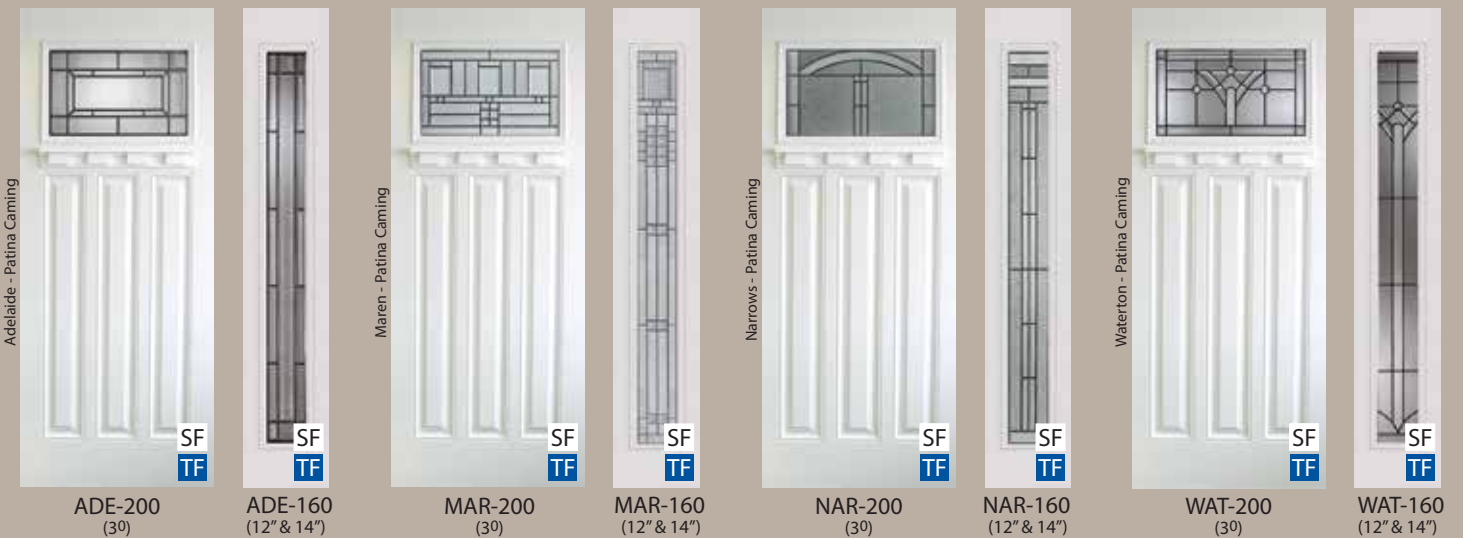

Adelaide - Patina Caming

Maren - Patina Caming

Narrows - Patina Caming

Waterton - Patina Caming

ADE-200 (30)

ADE-160 (12" & 14")

MAR-200 (30)

MAR-160 (12" & 14")

NAR-200 (30)

NAR-160 (12" & 14")

WAT-200 (30)

WAT-160 (12" & 14")

SF Smooth Fiberglass TF Textured Fiberglass

Doors shown with optional C-21 shelf.





Artisan - Patina Caming

SF  
TF

ART-200  
(30)



SF  
TF

ART-160  
(12" & 14")



Flora - Patina Caming

SF  
TF

FIO-200  
(30)



SF  
TF

FIO-160  
(12" & 14")



Brentwood - Zinc Caming

SF  
TF

BRE-200  
(30)



SF  
TF

BRE-160  
(12" & 14")



Beveled Glass, Clear I.G. / Patina Caming

SF  
TF

FLT-200  
(30)



SF  
TF

FLF-160  
(12" & 14")



Beveled Glass, Clear I.G. / Patina Caming

SF  
TF

FLS-200  
(30)



SF  
TF

FLF-160  
(12" & 14")

### Craftsman Transom



■ FLF-6312 / FLF-6712 / FLF-7212

Refer to Page 98 for Transom Size Information.

■ Extended Leadtime Required.

### C-21 Craftsman Shelf



SF  
TF

(Optional)

## 68 & 80 Craftsman 4-Panel Collection



Patina, Bevel Clear I.G.



Patina

No Matching Sidelite Available

6/8  
8/0  
SF  
TF

6/8  
8/0  
SF  
TF

FLF-64  
FLF-6480  
(30)

SPR-64  
SPR-6480  
(30)

**NO Door Shelf Available**



Flora FIO-200 doors.

Doors shown with optional C-21 shelf.

# 6<sup>8</sup> Smooth Fiberglass Heritage Craftsman



SFHER-204 Door.

# 6<sup>8</sup> Smooth Fiberglass Heritage Craftsman

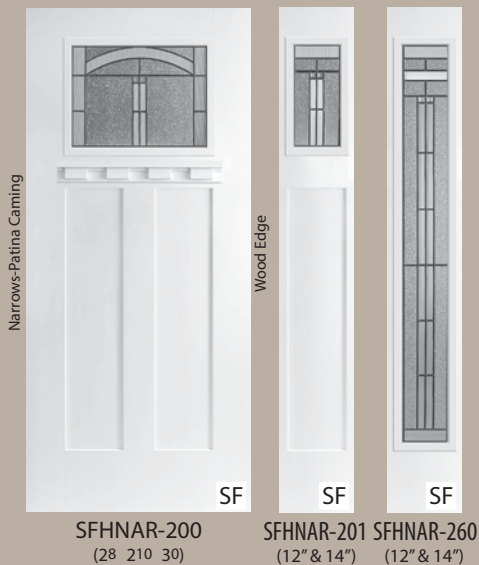
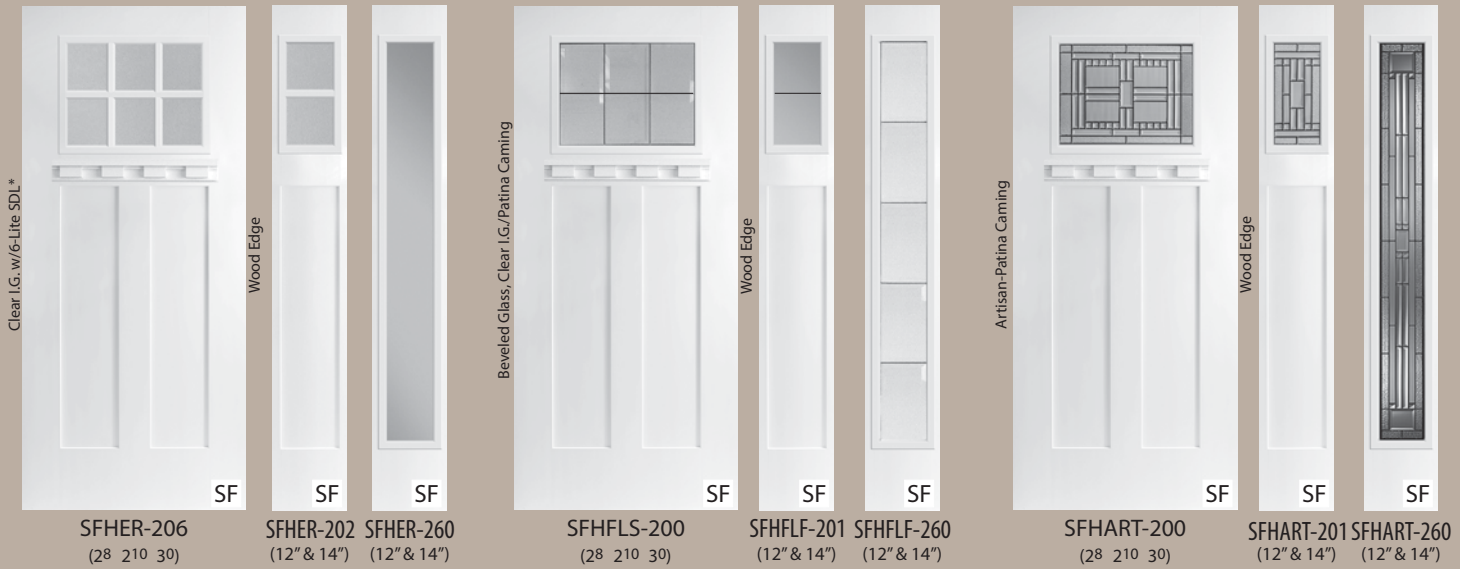

**Heritage Lite Kit Frame**



Lite kit frame features clean, classic lines, and is reglazeable.

**Simulated Divided Lite**



Simulated divided lite bars are 5/16" thick x 1-1/8" wide.

**C-21P Craftsman Shelf**



(Optional)

SF Smooth Fiberglass - \*SDL: Simulated Divided Lite - Additional Obscure Glass Options Available, See Pages 36-37. - Doors shown with optional C21 Craftsman Shelf.

8<sup>0</sup> Smooth Fiberglass Heritage Craftsman



SFHFLS-300 door.

# 80 Smooth Fiberglass Heritage Craftsman

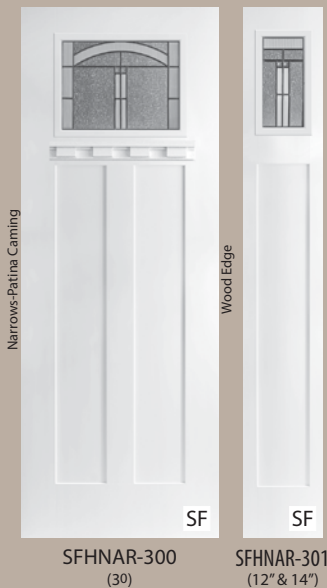
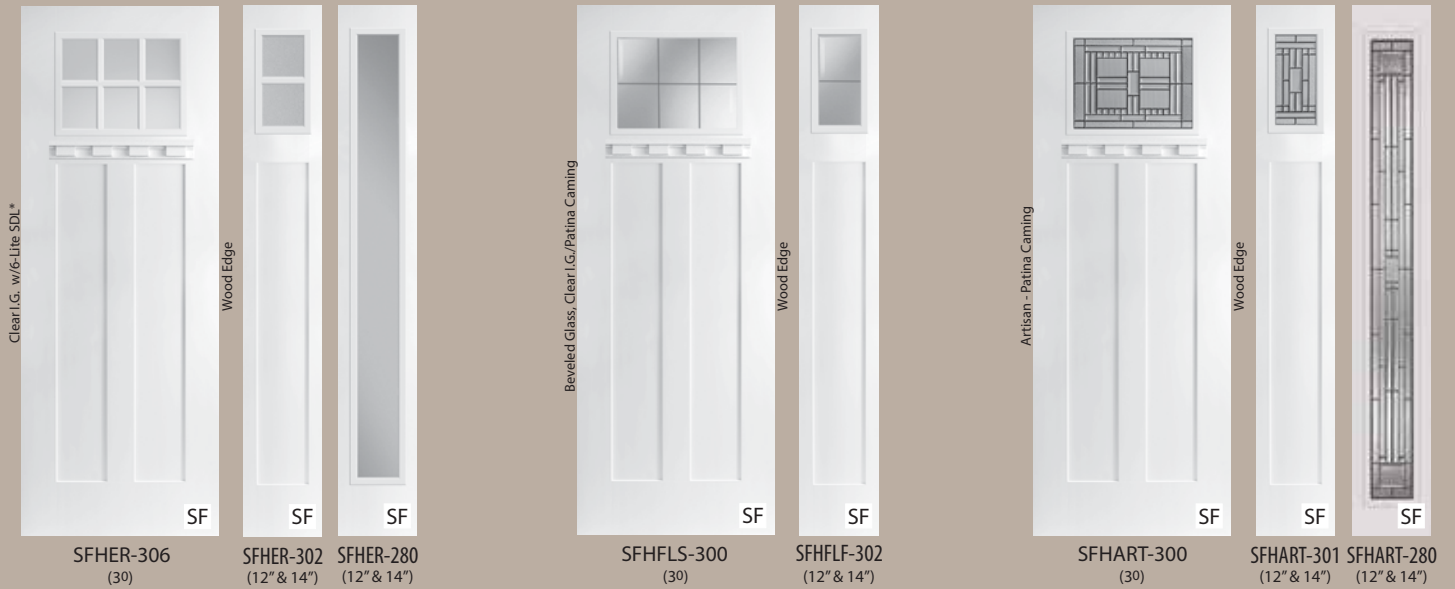

## Heritage Lite Kit Frame



Lite kit frame features clean, classic lines, and is reglazeable.

## Simulated Divided Lite



Simulated divided lite bars are 5/16" thick x 1-1/8" wide.

## C-21P Craftsman Shelf



(Optional)

SF Smooth Fiberglass - \*SDL: Simulated Divided Lite - Additional Obscure Glass Options Available, See Pages 36-37. - Doors shown with optional C21 Craftsman Shelf.

# 6<sup>8</sup> Fir-Grain Textured Fiberglass Heritage Craftsman

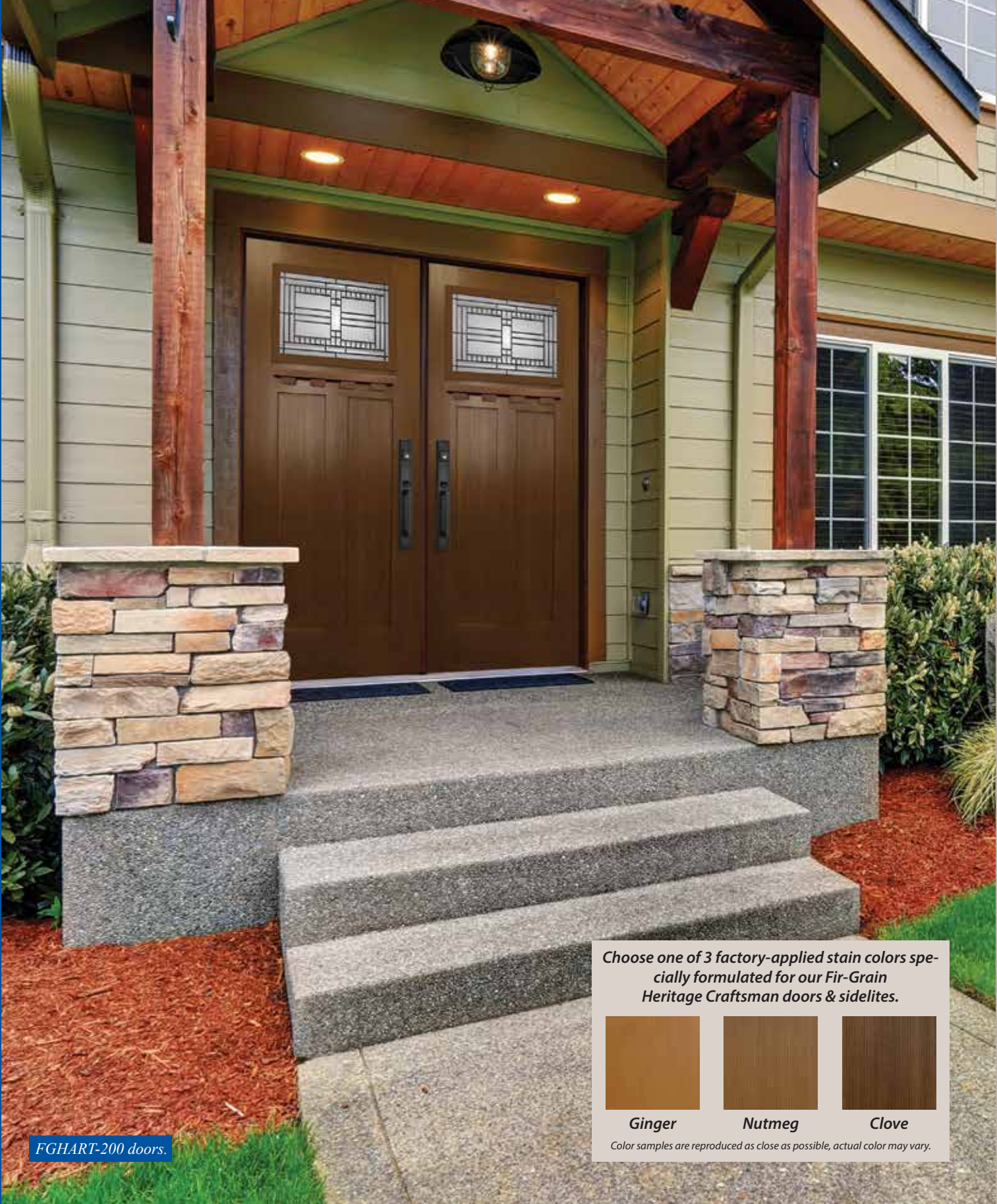

Choose one of 3 factory-applied stain colors specially formulated for our Fir-Grain Heritage Craftsman doors & sidelites.



Ginger



Nutmeg



Clove

Color samples are reproduced as close as possible, actual color may vary.

FGHART-200 doors.

# 6<sup>8</sup> Fir-Grain Textured Fiberglass Heritage Craftsman



**Heritage Lite Kit Frame**



Lite kit frame features clean, classic lines, and is reglazeable.

**Simulated Divided Lite**



Simulated divided lite bars are 5/16" thick x 1-1/8" wide.

**C-21F Craftsman Shelf**



(Optional)

# 8<sup>0</sup> Fir-Grain Textured Fiberglass Heritage Craftsman



Choose one of 3 factory-applied stain colors specially formulated for our Fir-Grain Heritage Craftsman doors & sidelites.



Ginger



Nutmeg



Clove

Color samples are reproduced as close as possible, actual color may vary.

FGHER-306 door.



# 8<sup>0</sup> Fir-Grain Textured Fiberglass Heritage Craftsman



Clear I.G.

Wood Edge

FG

FGHER-300  
(30)



FG

FGHER-301  
(12" & 14")



FG

FGHER-280  
(12" & 14")



Clear I.G. w/3-Lite SDL\*

Wood Edge

FG

FGHER-303  
(30)



FG

FGHER-301  
(12" & 14")



FG

FGHER-280  
(12" & 14")



Clear I.G. w/4-Lite SDL\*

Wood Edge

FG

FGHER-304  
(30)



FG

FGHER-302  
(12" & 14")



FG

FGHER-280  
(12" & 14")



Clear I.G. w/6-Lite SDL\*

Wood Edge

FG

FGHER-306  
(30)



FG

FGHER-302  
(12" & 14")



FG

FGHER-280  
(12" & 14")



Beveled Glass, Clear I.G. / Patina Caming

FG

FGHFLS-300  
(30)



Wood Edge

FG

FGHLF-302  
(12" & 14")



Artisan-Patina Caming

FG

FGHART-300  
(30)



Wood Edge

FG

FGHART-301  
(12" & 14")



FG

FGHART-280  
(12" & 14")



Narrows-Patina Caming

FG

FGHNAR-300  
(30)



Wood Edge

FG

FGHNAR-301  
(12" & 14")

## Heritage Lite Kit Frame



Lite kit frame features clean, classic lines, and is reglazeable.

## Simulated Divided Lite



Simulated divided lite bars are 5/16" thick x 1-1/8" wide.

## C-21F Craftsman Shelf



(Optional)

FG Fir Grain Texture - \* SDL: Simulated Divided Lite - Additional Obscure Glass Options Available, See Pages 36-37. - Doors shown with optional C21F Craftsman Shelf.



Chateau CHA-439W door with CHA-160W sidelites.

# 6<sup>8</sup> Rustic Collection "Rustic Hardwood Grain"



RUS1PV  
(30)



RUS2PV  
(30)



RUS2PF  
(30)



Standard Lite Kit Frame (Not Wrought Iron)

RUSL20  
(12" & 14")



Chateau - Wrought Iron Frame, Wrought Iron Grille

CHA-439W  
(30)

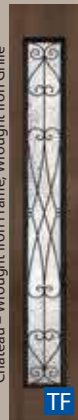

Chateau - Wrought Iron Frame, Wrought Iron Grille

CHA-160W  
(12" & 14")

TF Textured Fiberglass

## 6<sup>th</sup> Rustic Collection (cont.)



Canterbury - Wrought Iron frame, Patina Caming

TF

CAN-430WVG  
(30)



Canterbury - Wrought Iron frame, Patina Caming

TF

CAN-430W  
(30)



Canterbury - Wrought Iron Frame, Patina Caming

TF

CAN-160W  
(12" & 14")



TF

RUS1PV80  
(30)



TF

RUS2PV80  
(30, 36)



Standard Lite Kit Frame (Not Wrought Iron)

TF

RUSL280  
(14")



Chateau - Wrought Iron Frame, Wrought Iron Grille

TF

CHA-449W  
(30)

## Decorative Options for Rustic Doors

Clavos, hinge straps and speakeasies add an authentic touch to your Rustic door.

### Clavos

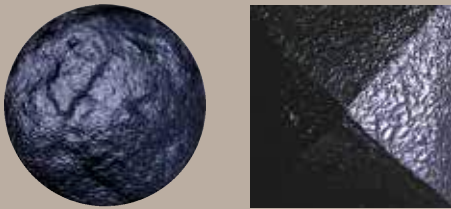

Codel offers clavos in 1-1/2" round or 1-1/2" square decorative black metal. Clavos and hinge straps are shipped loose so the customer can apply them on site in the design of their choice. (Clavos and hinge straps come installed on prefinished doors.)

### Straps & Clavos



1-1/2" Clavos and 18" hinge straps can be added to Rustic doors.

### Essex Speakeasy

A Speakeasy adds a touch of old world charm. Seedy Reamy glass door can open; when closed, Speakeasy seals tightly to prevent air infiltration. (Size: 10" wide x 12" high.)



(Exterior View)

(Interior View)



### Lite Kit Frame

The galvanized frame is coated prior to powder coating for additional weather protection. It features a distinctive iron grille that enhances the old-world styling of our Rustic Door Collection.

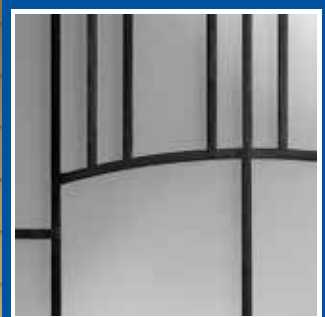

*Forged Iron*

Standard Low-E with Argon

Palisades SFPAL460801P w/SFPAL16080 Sidelites.

# 6<sup>8</sup> & 7<sup>0</sup> Palisades Collection



PAL-440  
(28 30)

SF  
TF



PAL-4401P  
(30)

SF  
FG



PAL-460  
6-8 (28 210 30)  
7-0 (28 30) SF Only

SF  
TF  
FG



PAL-240  
(12" & 14")

SF  
TF  
FG



PAL-160  
6-8 (12" & 14")  
7-0 (14") SF Only

SF  
TF

# 8° Palisades Collection

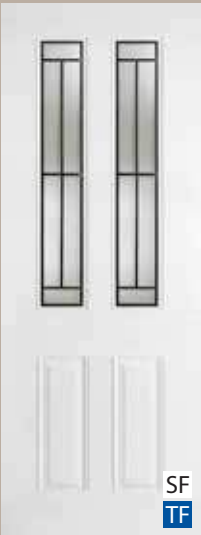

PAL-24080  
(SF - 28 30)  
(TF - 30)

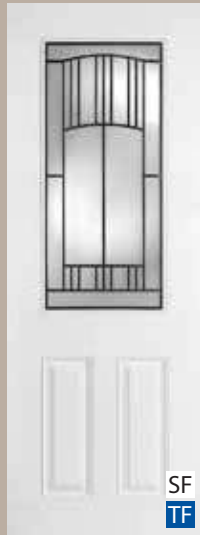

PAL-44080  
(SF - 28 30)  
(TF - 30)

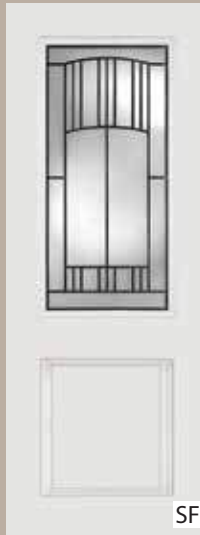

PAL-440801P  
(30)

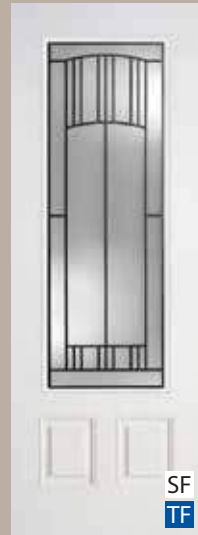

PAL-46080  
(30 36)

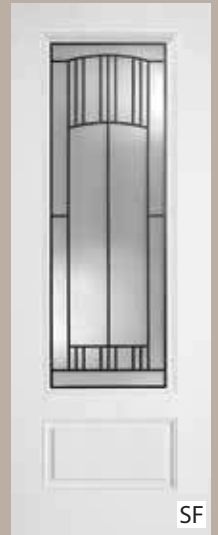

PAL-460801P  
(30)



PAL-24080  
(12" & 14")



PAL-16080  
(12" & 14")

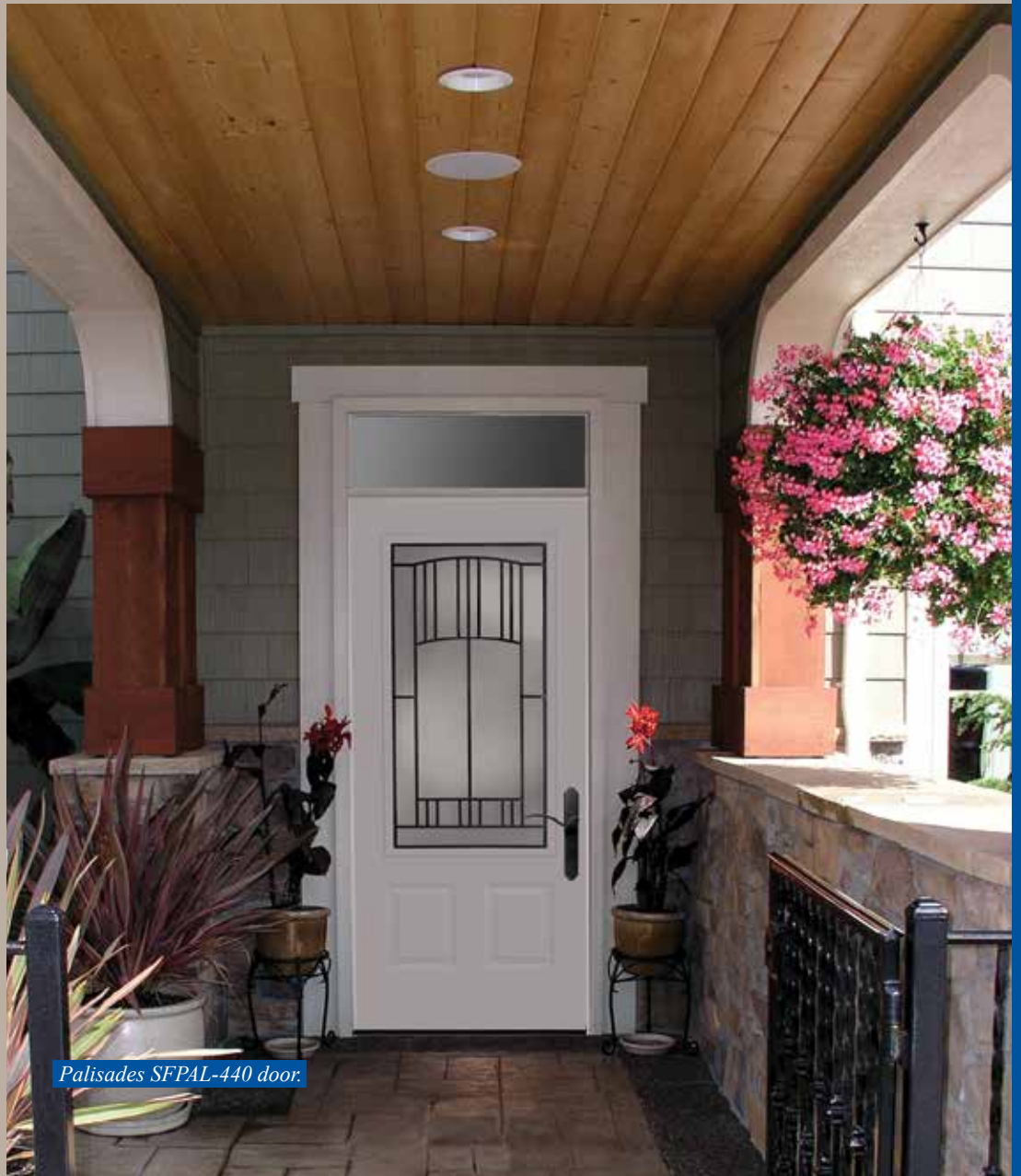

Palisades SFPAL-440 door.



**Zinc Claming**  
Standard Low-E with Argon



# 6<sup>8</sup> & 7<sup>0</sup> Cirque Collection

Cirque SFCIR480 doors.



CIR-440  
(28 30)

SF  
TF



CIR-4401P  
(30)

SF  
FG



CIR-240  
(12" & 14")

SF  
TF  
FG



CIR-460  
6-8 (28 210 30)  
7-0 (28 30) SF Only

SF  
TF  
FG



CIR-160  
6-8 (12" & 14")  
7-0 (14") SF Only

SF  
TF

**CODEL**  
ENTRY SYSTEMS™

# 8<sup>o</sup> Cirque Collection

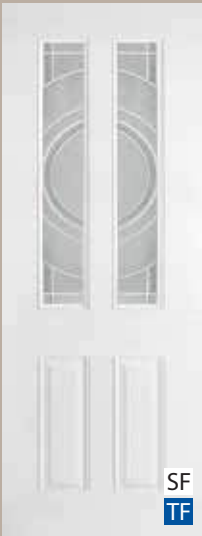

SF  
TF

CIR-24080  
(SF - 28 30)  
(TF - 30)



SF  
TF

CIR-44080  
(SF - 28 30)  
(TF - 30)



SF

CIR-440801P  
(30)



SF  
TF

CIR-46080  
(30 36)



SF

CIR-460801P  
(30)



SF  
TF

CIR-480  
(28 30 36)



SF  
TF

CIR-24080  
(12" & 14")



SF  
TF

CIR-16080  
(12" & 14")



SF  
TF

CIR-280  
(12" & 14")



Fir Grain Cirque FGCIR-4401P door.

SFCAN-460 door with SFCAN-160 sidelites & CAN-6712 transom.



Patina Caming  
Standard Low-E with Argon

# 6<sup>8</sup> & 7<sup>0</sup> Canterbury Collection



SF  
TF

CAN-230  
6-8 (26 28 210 30)  
7-0 (28 30) SF Only



SF  
TF  
FG

CAN-430  
6-8 (28 210 30)  
7-0 (28 30) SF Only



SF

CAN-4301P  
(28 210 30)



SF

CAN-4301PC  
(28 30)



SF  
TF

CAN-440  
(28 30)



SF  
FG

CAN-4401P  
(30)



SF  
TF  
FG

CAN-460  
6-8 (28 210 30)  
7-0 (28 30) SF Only



SF  
TF

CAN-949  
(30)



SF  
TF  
FG

CAN-230  
6-8 (12" & 14")  
7-0 (14") SF Only



SF  
TF  
FG

CAN-240  
(12" & 14")



SF  
TF

CAN-160  
6-8 (12" & 14")  
7-0 (14") SF Only



# 8° Canterbury Collection



CAN-24080  
(SF - 28 30)  
(TF - 30)



CAN-44080  
(SF - 28 30)  
(TF - 30)

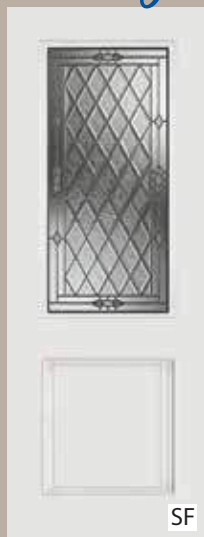

CAN-440801P  
(30)



CAN-46080  
(30 36)



CAN-460801P  
(30)



CAN-24080  
(12" & 14")



CAN-16080  
(12" & 14")

SFCAN-46080 door with SFCAN-16080 sidelite.



## Canterbury Transom



■ CAN-6312 / CAN-6712 / CAN-7212

■ Extended Leadtime Required.  
Refer to Page 98 for Transom Size Information.



● *Patina Caming*  
Standard Low-E with Argon

# 6<sup>8</sup> & 7<sup>0</sup> Caspian Collection

*Caspian SFCAS-430 door.*



CASP-230  
6-8 (26 28 210 30)  
7-0 (28 30) SF Only



CASP-430  
6-8 (28 210 30)  
7-0 (28 30) SF Only



CASP-4301P  
(28 210 30)



CASP-4301PC  
(28 30)



CASP-440  
(28 30)



CASP-4401P  
(30)

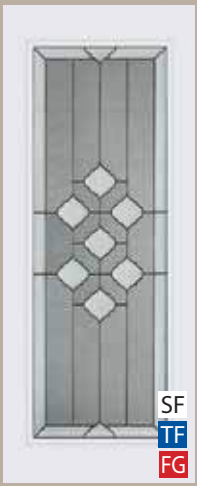

CASP-460  
6-8 (28 210 30)  
7-0 (28 30) SF Only



CASP-230  
6-8 (12" & 14")  
7-0 (14") SF Only

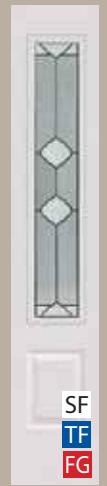

CASP-240  
(12" & 14")

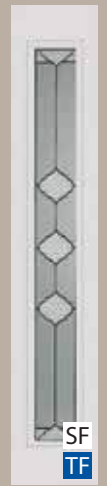

CASP-160  
6-8 (12" & 14")  
7-0 (14") SF Only



# 8° Caspian Collection

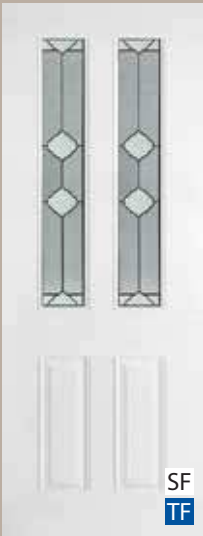

CAS-24080  
(SF - 28 30)  
(TF - 30)



CAS-44080  
(SF - 28 30)  
(TF - 30)



CAS-440801P  
(30)



CAS-46080  
(30 36)



CAS-460801P  
(30)



CAS-24080  
(12" & 14")



CAS-16080  
(12" & 14")

## Caspian Transom



■ CAS-6312 / CAS-6712 / CAS-7212

■ Extended Leadtime Required.  
Refer to Page 98 for Transom Size Information.



Caspian CAS-440 door.

Brentwood SFBRE-46080 door with (2) SFBRE-16080 sidelites.



# 6<sup>8</sup> & 7<sup>0</sup> Brentwood Collection



**BRE-230**  
6-8 (26 28 210 30)  
7-0 (28 30) SF Only

SF  
TF



**BRE-430**  
6-8 (28 210 30)  
7-0 (28 30) SF Only

SF  
TF  
FG



**BRE-4301P**  
(28 210 30)

SF



**BRE-4301PC**  
(28 30)

SF



**BRE-440**  
(28 30)

SF  
TF



**BRE-4401P**  
(30)

SF  
FG



**BRE-460**  
6-8 (28 210 30)  
7-0 (28 30) SF Only

SF  
TF  
FG



**BRE-253**  
(30)

SF  
TF



**BRE-230**  
6-8 (12" & 14")  
7-0 (14") SF Only

SF  
TF  
FG



**BRE-240**  
(12" & 14")

SF  
TF  
FG



**BRE-160**  
6-8 (12" & 14")  
7-0 (14") SF Only

SF  
TF

# 8° Brentwood Collection



BRE-24080  
(SF - 28" 30")  
(TF - 30")



BRE-44080  
(SF - 28" 30")  
(TF - 30")



BRE-440801P  
(30")



BRE-46080  
(30" 36")



BRE-460801P  
(30")



BRE-258  
(30")



BRE-25080  
(30" 36")



BRE-24080  
(12" & 14")



BRE-16080  
(12" & 14")



Brentwood SFBRE-430 door and SFBRE-230 sidelite.

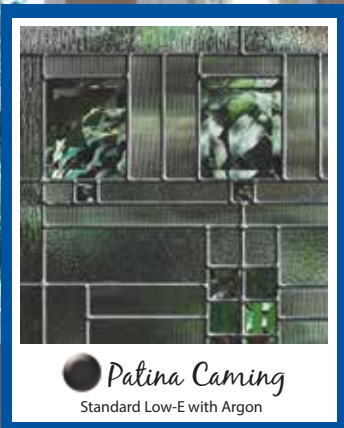

# 6<sup>8</sup> & 7<sup>0</sup> Maren Collection

Maren SFMAR-46080 door:



MAR-230  
6-8 (26 28 210 30)  
7-0 (28 30) SF Only



MAR-430  
6-8 (28 210 30)  
7-0 (28 30) SF Only

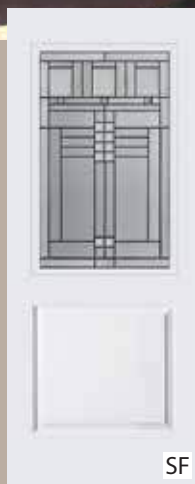

MAR-4301P  
(28 210 30)



MAR-4301PC  
(28 30)



MAR-440  
(28 30)



MAR-4401P  
(30)



MAR-460  
6-8 (28 210 30)  
7-0 (28 30) SF Only



MAR-230  
6-8 (12" & 14")  
7-0 (14") SF Only



MAR-240  
(12" & 14")



MAR-160  
6-8 (12" & 14")  
7-0 (14") SF Only

# 8<sup>o</sup> Maren Collection

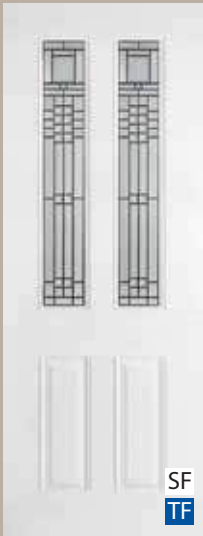

MAR-24080  
(SF - 28 30)  
(TF - 30)



MAR-44080  
(SF - 28 30)  
(TF - 30)



MAR-440801P  
(30)



MAR-46080  
(30 36)



MAR-460801P  
(30)



MAR-24080  
(12" & 14")



MAR-16080  
(12" & 14")

## Maren Transom



■ MAR-6312 / MAR-6712 / MAR-7212

■ Extended Leadtime Required.  
Refer to Page 98 for Transom Size Information.



Maren SFMAR-200 door (See page 48).

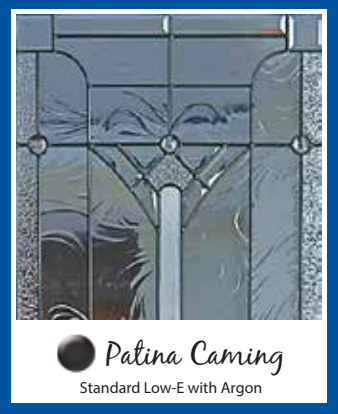

Waterton SFWAT-46080 door with SFWAT-16080 sidelite.

# 6<sup>8</sup> & 7<sup>0</sup> Waterton Collection



WAT-230  
6-8 (26 28 210 30)  
7-0 (28 30) SF Only



WAT-430  
6-8 (28 210 30)  
7-0 (28 30) SF Only



WAT-4301P  
(28 210 30)



WAT-4301PC  
(28 30)



WAT-440  
(28 30)



WAT-4401P  
(30)



WAT-460  
6-8 (28 210 30)  
7-0 (28 30) SF Only



WAT-64  
(30)



WAT-230  
6-8 (12" & 14")  
7-0 (14") SF Only



WAT-240  
(12" & 14")



WAT-160  
6-8 (12" & 14")  
7-0 (14") SF Only





# 8° Waterton Collection

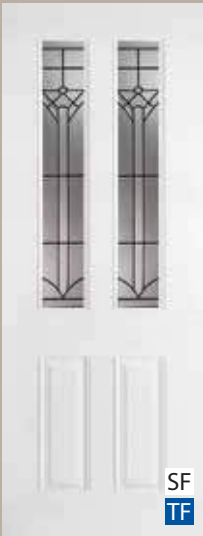

WAT-24080  
(SF - 28 30)  
(TF - 30)



WAT-44080  
(SF - 28 30)  
(TF - 30)



WAT-440801P  
(30)



WAT-46080  
(30 36)



WAT-460801P  
(30)



WAT-480  
(28 30 36)



WAT-24080  
(12" & 14")



WAT-16080  
(12" & 14")



WAT-280  
(12" & 14")

## Waterton Transom



■ WAT-6312 / WAT-6712 / WAT-7212

■ Extended Leadtime Required.  
Refer to Page 98 for Transom Size Information.



Waterton WAT-460 door.

Artisan SFART-46080 doors with (2) SFART-16080 sidelites.

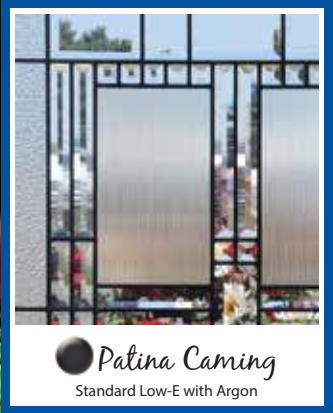

6<sup>th</sup> & 7<sup>th</sup> Artisan Collection



ART-230  
6-8 (26 28 210 30)  
7-0 (28 30) SF Only

SF  
TF



ART-430  
6-8 (28 210 30)  
7-0 (28 30) SF Only

SF  
TF  
FG



ART-4301P  
(28 210 30)

SF



ART-4301PC  
(28 30)

SF



ART-440  
(28 30)

SF  
TF



ART-4401P  
(30)

SF  
FG



ART-460  
6-8 (28 210 30)  
7-0 (28 30) SF Only

SF  
TF  
FG



ART-230  
6-8 (12" & 14")  
7-0 (14") SF Only

SF  
TF  
FG



ART-240  
(12" & 14")

SF  
TF  
FG

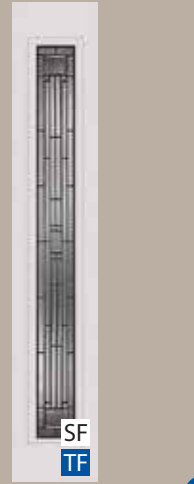

ART-160  
6-8 (12" & 14")  
7-0 (14") SF Only

SF  
TF

**CODEL**  
ENTRY SYSTEMS™

# 8<sup>o</sup> Artisan Collection



SF  
TF

ART-24080  
(SF - 28 30)  
(TF - 30)



SF  
TF

ART-44080  
(SF - 28 30)  
(TF - 30)



SF

ART-440801P  
(30)



SF  
TF

ART-46080  
(30 36)

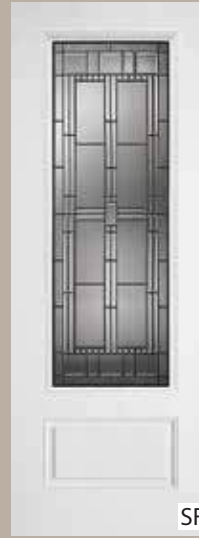

SF

ART-460801P  
(30)



SF  
TF

ART-480  
(28 30 36)



SF  
TF

ART-24080  
(12" & 14")



SF  
TF

ART-16080  
(12" & 14")



SF  
TF

ART-280  
(12" & 14")

## Artisan Transom



■ ART-6312 / ART-6712 / ART-4212 / ART-7212

■ Extended Leadtime Required.  
Refer to Page 98 for Transom Size Information.



Artisan SFART-460 doors.



**Patina Caming**  
Standard Low-E with Argon

# 6<sup>8</sup> & 7<sup>0</sup> Adelaide Collection

Adelaide SFADE-440 door.



ADE-230  
6-8 (26 28 210 30)  
7-0 (28 30) SF Only

SF  
TF



ADE-430  
6-8 (28 210 30)  
7-0 (28 30) SF Only

SF  
TF  
FG



ADE-4301P  
(28 210 30)

SF



ADE-4301PC  
(28 30)

SF



ADE-440  
(28 30)

SF  
TF



ADE-4401P  
(30)

SF  
FG



ADE-460  
6-8 (28 210 30)  
7-0 (28 30) SF Only

SF  
TF  
FG



ADE-230  
6-8 (12" & 14")  
7-0 (14") SF Only

SF  
TF  
FG



ADE-240  
(12" & 14")

SF  
TF  
FG



ADE-160  
6-8 (12" & 14")  
7-0 (14") SF Only

SF  
TF

# 8<sup>o</sup> Adelaide Collection

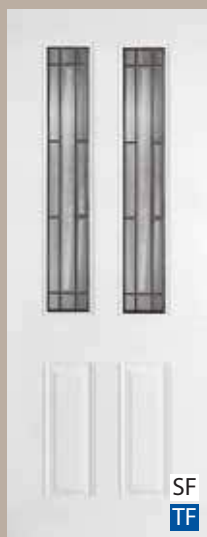

SF  
TF

ADE-24080  
(SF - 28 30)  
(TF - 30)

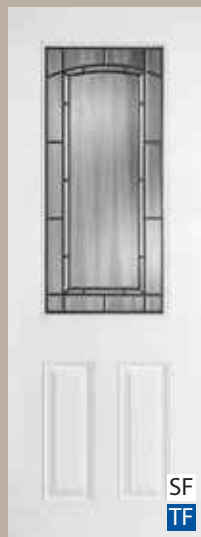

SF  
TF

ADE-44080  
(SF - 28 30)  
(TF - 30)



SF

ADE-440801P  
(30)

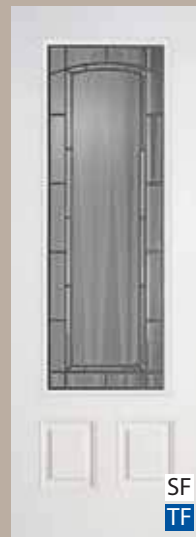

SF  
TF

ADE-46080  
(30 36)

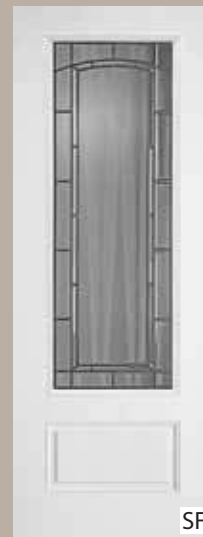

SF

ADE-460801P  
(30)



SF  
TF

ADE-24080  
(12" & 14")



SF  
TF

ADE-16080  
(12" & 14")

## Adelaide Transom



■ ADE-6312 / ADE-6712 / ADE-7212

■ Extended Leadtime Required.  
Refer to Page 98 for Transom Size Information.



Adelaide TFADE-24080 doors.



6° & 7° Narrows Collection

Narrows SFNAR-440 doors.



NAR-230  
6-8 (26 28 210 30)  
7-0 (28 30) SF Only

SF  
TF



NAR-430  
6-8 (28 210 30)  
7-0 (28 30) SF Only

SF  
TF  
FG



NAR-4301P  
(28 210 30)

SF



NAR-4301PC  
(28 30)

SF



NAR-440  
(28 30)

SF  
TF



NAR-4401P  
(30)

SF  
FG



NAR-460  
6-8 (28 210 30)  
7-0 (28 30) SF Only

SF  
TF  
FG



NAR-230  
6-8 (12" & 14")  
7-0 (14") SF Only

SF  
TF  
FG



NAR-240  
(12" & 14")

SF  
TF  
FG

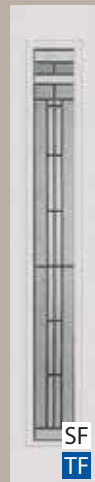

NAR-160  
6-8 (12" & 14")  
7-0 (14") SF Only

SF  
TF

CODEL  
ENTRY SYSTEMS™

# 8<sup>o</sup> Narrows Collection

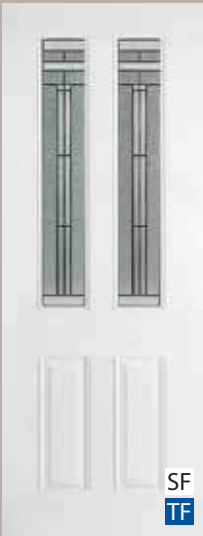

NAR-24080  
(SF - 28 30)  
(TF - 30)



NAR-44080  
(SF - 28 30)  
(TF - 30)



NAR-440801P  
(30)



NAR-46080  
(30 36)



NAR-460801P  
(30)



NAR-24080  
(12" & 14")



NAR-16080  
(12" & 14")



Narrows SFNAR-430 door.



# 6<sup>8</sup> & 7<sup>0</sup> Fiora Collection

Fiora SFFIO-460 door with (2) SFFIO-160 sidelites.



**FIO-230**  
6-8 (26 28 210 30)  
7-0 (28 30) SF Only

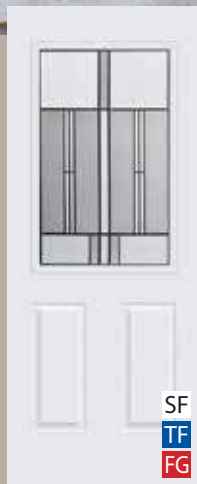

**FIO-430**  
6-8 (28 210 30)  
7-0 (28 30) SF Only



**FIO-4301P**  
(28 210 30)



**FIO-4301PC**  
(28 30)

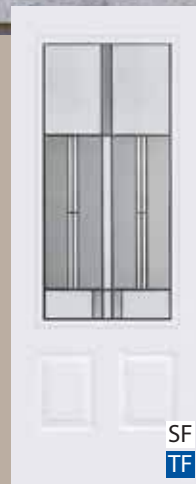

**FIO-440**  
(28 30)



**FIO-4401P**  
(30)



**FIO-460**  
6-8 (28 210 30)  
7-0 (28 30) SF Only



**FIO-230**  
6-8 (12" & 14")  
7-0 (14") SF Only



**FIO-240**  
(12" & 14")



**FIO-160**  
6-8 (12" & 14")  
7-0 (14") SF Only

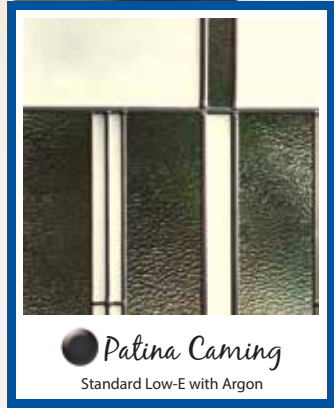



# 8<sup>o</sup> Fiora Collection

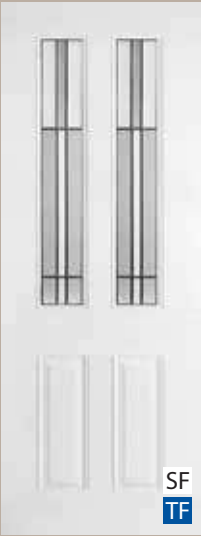

FIO-24080  
(SF - 28 30)  
(TF - 30)



FIO-44080  
(SF - 28 30)  
(TF - 30)



FIO-440801P  
(30)

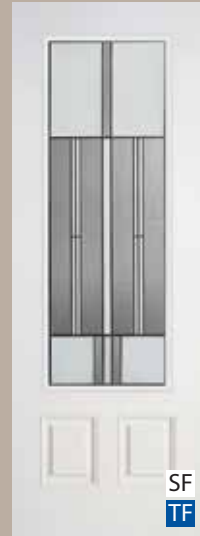

FIO-46080  
(30 36)



FIO-460801P  
(30)



FIO-24080  
(12" & 14")



FIO-16080  
(12" & 14")

## Fiora Transom



■ FIO-6312 / FIO-6712 / FIO-7212

■ Extended Leadtime Required.  
Refer to Page 98 for Transom Size Information.



Fiora SFFIO-430 door.

Modena TFMOD-460 door with TFMOD-160 Sidelite.



Patina Caming  
Standard Low-E with Argon

# 6<sup>8</sup> & 7<sup>0</sup> Modena Collection



MOD-230  
6-8 (26 28 210 30)  
7-0 (28 30) SF Only

SF  
TF



MOD-430  
6-8 (28 210 30)  
7-0 (28 30) SF Only

SF  
TF  
FG



MOD-4301P  
(28 210 30)

SF



MOD-4301PC  
(28 30)

SF



MOD-440  
(28 30)

SF  
TF



MOD-4401P  
(30)

SF  
FG



MOD-460  
6-8 (28 210 30)  
7-0 (28 30) SF Only



MOD-230  
6-8 (12" & 14")  
7-0 (14") SF Only



MOD-240  
(12" & 14")



MOD-160  
6-8 (12" & 14")  
7-0 (14") SF Only

## 8<sup>o</sup> Modena Collection



MOD-24080  
(SF - 28 30)  
(TF - 30)

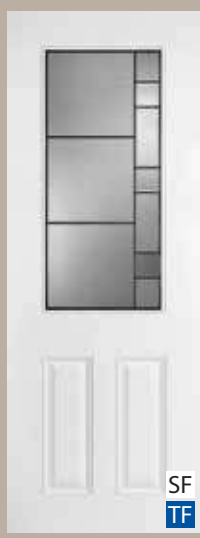

MOD-44080  
(SF - 28 30)  
(TF - 30)



MOD-440801P  
(30)

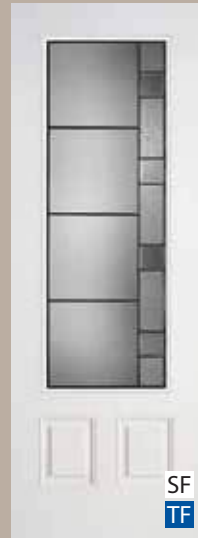

MOD-46080  
(30 36)

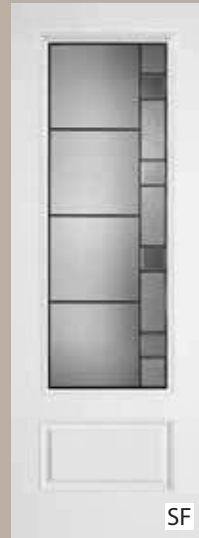

MOD-460801P  
(30)



MOD-24080  
(12" & 14")



MOD-16080  
(12" & 14")

## Modena Transom



■ MOD-6312 / MOD-6712 / MOD-7212

■ Extended Leadtime Required.  
Refer to Page 98 for Transom Size Information.



**Patina Caming**  
Standard Low-E with Argon

# 6<sup>8</sup> & 7<sup>0</sup> Harlow Collection

Harlow FG HAR-440IP door with (2) FG HAR-240 sidelites.



SF  
TF

**HAR-230**  
6-8 (26 28 210 30)  
7-0 (28 30) SF Only



SF  
TF  
FG

**HAR-430**  
6-8 (28 210 30)  
7-0 (28 30) SF Only



SF

**HAR-4301P**  
(28 210 30)



SF

**HAR-4301PC**  
(28 30)



SF  
TF

**HAR-440**  
(28 30)



SF  
FG

**HAR-4401P**  
(30)



SF  
TF  
FG

**HAR-460**  
6-8 (28 210 30)  
7-0 (28 30) SF Only



SF  
TF  
FG

**HAR-230**  
6-8 (12" & 14")  
7-0 (14") SF Only



SF  
TF  
FG

**HAR-240**  
(12" & 14")



SF  
TF

**HAR-160**  
6-8 (12" & 14")  
7-0 (14") SF Only



# 8<sup>o</sup> Harlow Collection

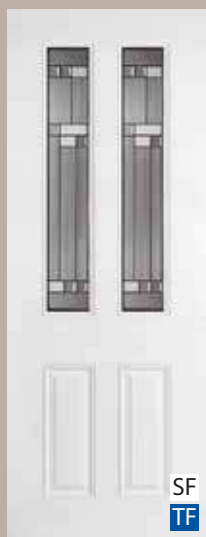

HAR-24080  
(SF - 28 30)  
(TF - 30)



HAR-44080  
(SF - 28 30)  
(TF - 30)



HAR-440801P  
(30)



HAR-46080  
(30 36)



HAR-460801P  
(30)



HAR-24080  
(12" & 14")



HAR-16080  
(12" & 14")



## Harlow Transom



■ HAR-6312 / HAR-6712 / HAR-7212

■ Extended Leadtime Required.  
Refer to Page 98 for Transom Size Information.





Harlow SFHAR-430 doors.



Zinc Caming  
 Brass Caming  
 Standard Low-E with Argon

# 6<sup>8</sup> & 7<sup>0</sup> Floret Collection

Floret SFFLO-1842OV door with (2) SFFLO-240 sidelites.

						
SF TF	SF TF FG	SF	SF	SF TF	SF FG	SF TF
FLO-230 6-8 (26 28 210 30) 7-0 (28 30) SF Only	FLO-430 6-8 (28 210 30) 7-0 (28 30) SF Only	FLO-4301P (28 210 30)	FLO-4301CP (28 30)	FLO-440 (28 30)	FLO-4401P (30)	FLO-1842OV (30)

SF Smooth Fiberglass TF Textured Fiberglass FG Fir Grain Textured Fiberglass



SF  
TF  
FG

FLO-230  
6-8 (12" & 14"  
7-0 (14") SF Only



SF  
TF  
FG

FLO-240  
(12" & 14")

## 8° Floret Collection



SF  
TF

FLO-24080  
(SF - 28 30)  
(TF - 30)



SF  
TF

FLO-44080  
(SF - 28 30)  
(TF - 30)



SF

FLO-440801P  
(30)



SF  
TF

FLO-24080  
(12" & 14")

## Floret Transom



■ FLO-6312 / FLO-6712 / FLO-7212

■ Extended Leadtime Required.  
Refer to Page 98 for Transom Size Information.



Floret TFFLO-430 door with TFFLO-230 sidelites.

Eloquence SF ELO-44080 doors.



6<sup>th</sup> & 7<sup>th</sup> Eloquence Collection



ELO-400  
(SF 28 210 30)  
(TF 26 28 210 30)



ELO-230  
6-8 (26 28 210 30)  
7-0 (28 30) SF Only



ELO-430  
6-8 (28 210 30)  
7-0 (28 30) SF Only



ELO-4301P  
(28 210 30)



ELO-4301PC  
(28 30)



ELO-440  
(28 30)



ELO-4401P  
(30)

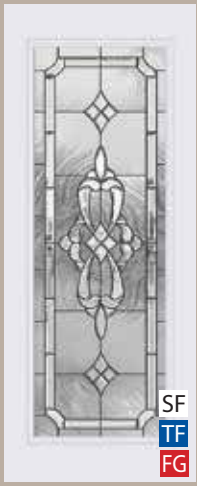

ELO-460  
6-8 (28 210 30)  
7-0 (28 30) SF Only



ELO-230  
6-8 (12" & 14")  
7-0 (14") SF Only



ELO-240  
(12" & 14")

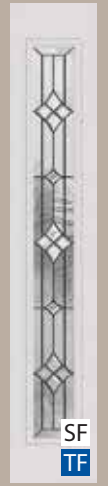

ELO-160  
6-8 (12" & 14")  
7-0 (14") SF Only



# 8<sup>o</sup> Eloquence Collection

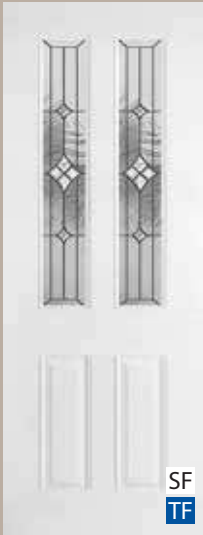

ELO-24080  
(SF - 28 30)  
(TF - 30)



ELO-44080  
(SF - 28 30)  
(TF - 30)

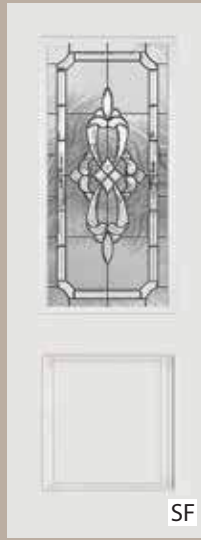

ELO-440801P  
(30)

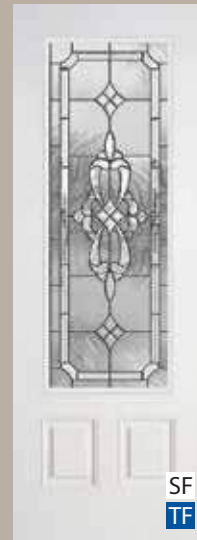

ELO-46080  
(30 36)



ELO-460801P  
(30)



ELO-24080  
(12" & 14")



ELO-16080  
(12" & 14")



Eloquence ELO-46080 door with ELO-16080 sidelites.



**Patina Caming**  
Standard Low-E with Argon

# 6<sup>8</sup> & 7<sup>0</sup> Sonora Collection

Sonora SFSON-44080 door.



**SON-230**  
6-8 (26 28 210 30)  
7-0 (28 30) SF Only

SF  
TF



**SON-430**  
6-8 (28 210 30)  
7-0 (28 30) SF Only

SF  
TF  
FG



**SON-4301P**  
(28 210 30)

SF



**SON-4301PC**  
(28 30)

SF



**SON-440**  
(28 30)

SF  
TF



**SON-4401P**  
(30)

SF  
FG



**SON-460**  
6-8 (28 210 30)  
7-0 (28 30) SF Only

SF  
TF  
FG



**SON-230**  
6-8 (12" & 14")  
7-0 (14") SF Only

SF  
TF  
FG



**SON-240**  
(12" & 14")

SF  
TF  
FG

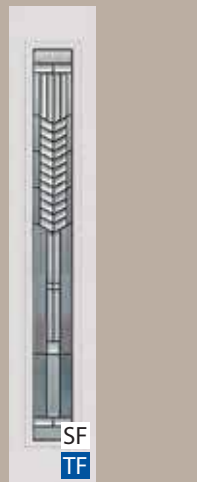

**SON-160**  
6-8 (12" & 14")  
7-0 (14") SF Only

SF  
TF

# 8<sup>o</sup> Sonora Collection



SON-24080  
(SF - 28 30)  
(TF - 30)



SON-44080  
(SF - 28 30)  
(TF - 30)



SON-440801P  
(30)



SON-46080  
(30 36)



SON-460801P  
(30)



SON-24080  
(12" & 14")



SON-16080  
(12" & 14")



Sonora SON-46080 doors.



*Sandblast*  
Standard Low-E with Argon

# 6<sup>8</sup> & 7<sup>0</sup> Vogue Collection

Vogue TFVOG-460 door.



SF  
TF

VOG-230  
6-8 (26 28 210 30)  
7-0 (28 30) SF Only



SF  
TF  
FG

VOG-430  
6-8 (28 210 30)  
7-0 (28 30) SF Only



SF

VOG-4301P  
(28 210 30)

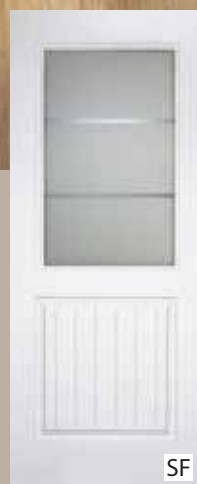

SF

VOG-4301PC  
(28 30)



SF  
TF

VOG-440  
(28 30)

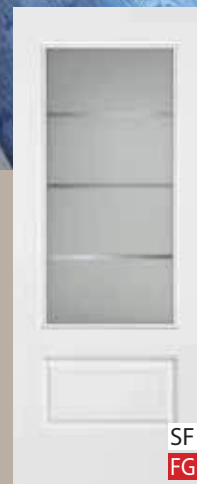

SF  
FG

VOG-4401P  
(30)



**VOG-460**  
 6-8 SF & TF (26 28 210 30)  
 6-8 FG (28 210 30)  
 7-0 (26 28 30) SF Only



**VOG-230**  
 6-8 (12" & 14")  
 7-0 (14") SF Only



**VOG-240**  
 (12" & 14")



**VOG-160**  
 6-8 (12" & 14")  
 7-0 (14") SF Only

## 8° Vogue Collection



**VOG-24080**  
 (SF - 28 30)  
 (TF - 30)



**VOG-44080**  
 (SF - 28 30)  
 (TF - 30)



**VOG-440801P**  
 (30)



**VOG-46080**  
 (30 36)

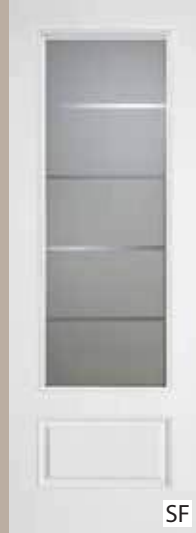

**VOG-460801P**  
 (30)



**VOG-24080**  
 (12" & 14")



**VOG-16080**  
 (12" & 14")

## Vogue Transom



■ VOG-6312 / VOG-6712 / VOG-7212

■ Extended Leadtime Required.  
 Refer to Page 98 for Transom Size Information.



**Zinc Claming**  
Standard Low-E with Argon



Inspire SFINS-440 door with (2) SFINS-240 sidelites.

# 6<sup>8</sup> & 7<sup>0</sup> Inspire Collection



SF  
TF

INS-400  
(SF 28 210 30)  
(TF 26 28 210 30)

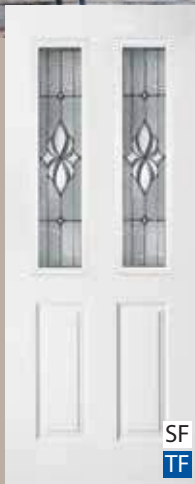

SF  
TF

INS-230  
6-8 (26 28 210 30)  
7-0 (28 30) SF Only

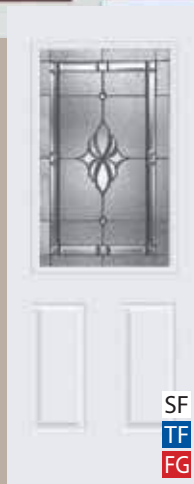

SF  
TF  
FG

INS-430  
6-8 (28 210 30)  
7-0 (28 30) SF Only

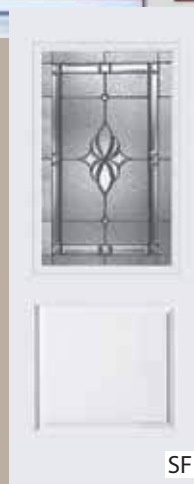

SF

INS-4301P  
(28 210 30)

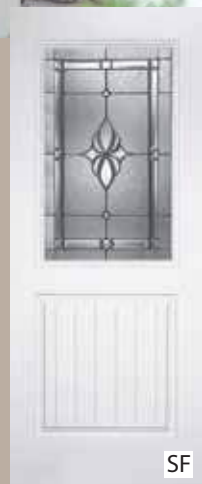

SF

INS-4301PC  
(28 30)



SF  
TF

INS-440  
(28 30)



SF  
FG

INS-4401P  
(30)



SF  
TF  
FG

INS-230  
6-8 (12" & 14")  
7-0 (14") SF Only



SF  
TF  
FG

INS-240  
(12" & 14")



Inspire SFINS-400 door with (2) SFINS-230 sidelites.

# 8<sup>o</sup> Inspire Collection



INS-24080  
(SF - 28 30)  
(TF - 30)



INS-44080  
(SF - 28 30)  
(TF - 30)



INS-440801P  
(30)



INS-24080  
(12" & 14")



Inspire SFINS-230 doors.

# Fiberglass Door Textures

**Smooth Fiberglass**

Unfinished

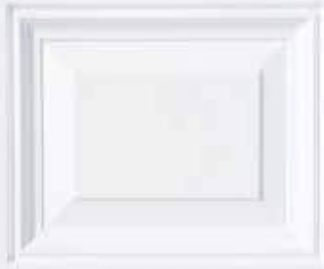

See Pages 20-25.

**Standard Oak Grain Textured Fiberglass**

Unfinished



See Pages 26-29.

**True White Oak Grain Textured Fiberglass**

Unfinished



See Page 33.

**Fir Grain Textured Fiberglass**

Unfinished



See Pages 30-31.

**Rustic Hardwood Grain Textured Fiberglass**

Unfinished



See Pages 58-59.

**Teak Textured Fiberglass**

Unfinished



See Page 47.

**Shaker Smooth Fiberglass**

Unfinished



See Pages 32 & 50-53.

**Shaker Fir Grain Textured Fiberglass**

Unfinished

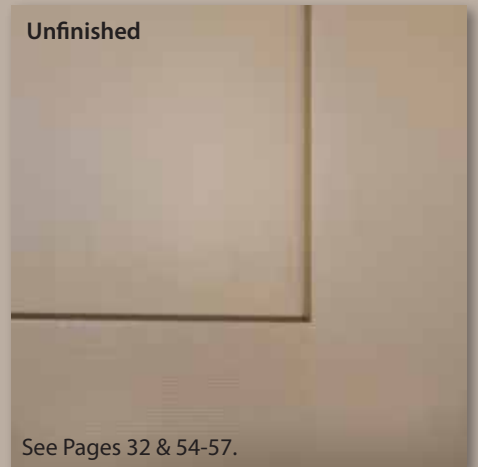

See Pages 32 & 54-57.



# Codel Door Configurations

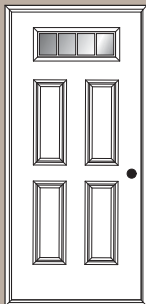

Single Prehung

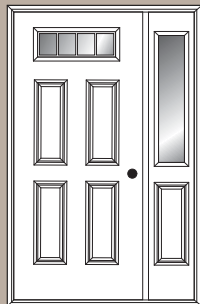

Also available with Sidelite on hinge side.

Single Prehung with Sidelite on the Strike Side  
(This is Codel's STANDARD)

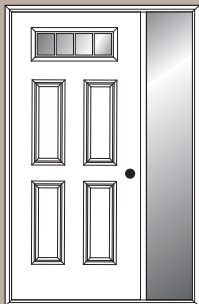

Also available with Sidelite on hinge side.

Single Prehung with "Direct-Set" Style Sidelite on the Strike Side  
(Available with Smooth or Oak Grain Textured Fiberglass Panel ONLY)



Also available with Direct Sidelite option.

Single Prehung with Two Sidelites

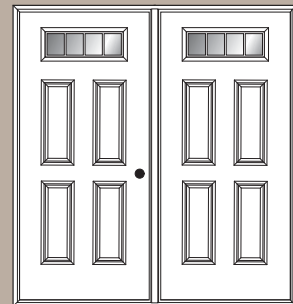

Double Prehung

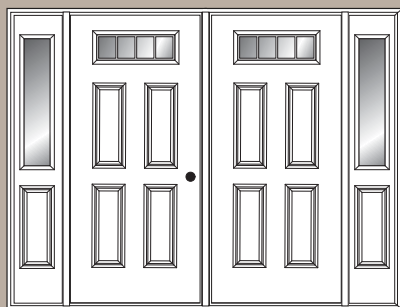

Also available with Direct Sidelite option.

\*Double Prehung with Two Sidelites

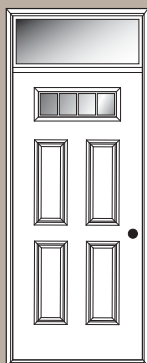

Single Prehung with Transom Above



Also available with Direct Sidelite option.

Single Prehung with Sidelite on the Strike Side and Transom Above

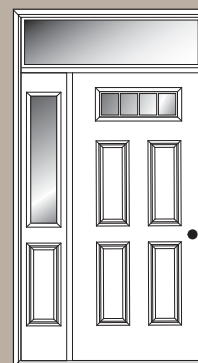

Also available with Direct Sidelite option.

Single Prehung with Sidelite on the Hinge Side and Transom Above



Also available with Direct Sidelite option.

Single Prehung with Two Sidelites and Transom Above



\*Double Prehung with Transom Above



Also available with Direct Sidelite option.

\*Double Prehung with Two Sidelites and Transom Above

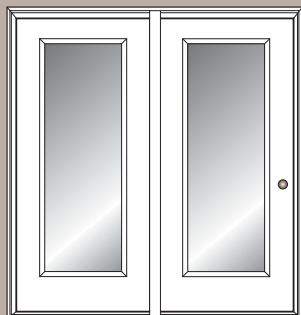

\*\*Patio Unit (Hinged off the Mull Post)  
R-H Active / L-H Swing

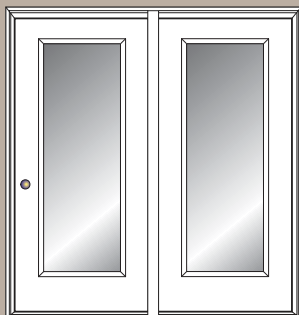

\*\*Patio Unit (Hinged off the Mull Post)  
L-H Active / R-H Swing

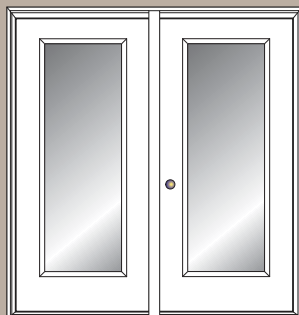

\*\*Patio Unit (Hinged off the Jamb)  
R-H Active / R-H Swing

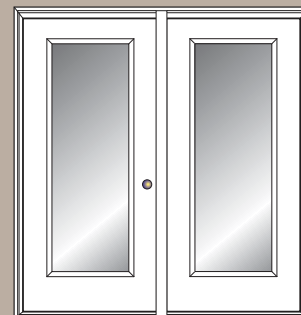

\*\*Patio Unit (Hinged off the Jamb)  
L-H Active / L-H Swing

\* **Double Prehung Unit:** (aka "Pair of Doors" and "French Doors") Both Doors Open - One active door and one inactive (passive) door. The inactive door has an astragal with flush bolts attached to it to keep it stationary when not in use.

\*\* **Patio Unit:** (aka "Atrium Unit") Only ONE door opens - One operable door and one fixed door - The fixed door will never open.

# DECORATIVE TRANSOM SIZES & DOOR HANDING

## DECORATIVE TRANSOM SIZES

SERIES	FOR USE OVER	ACTUAL GLASS SIZE	*NET UNIT SIZE
6312	Use Over 3-0 Door w/2 Ea. 12" Sidelites	62-3/4" x 12"	64-3/8" x 95-3/8"
6712	Use Over 3-0 Door w/2 Ea. 14" Sidelites	66-3/4" x 12"	68-3/8" x 95-3/8"
7212	Use Over 6-0 DBL. Door (NO Sidelites)	72-1/4" x 12"	73-7/8" x 95-3/8"

*\*Net Unit Height includes a 6-8 INSWING prehung with standard fixed or adjustable sill - For OUTSWING Unit, deduct 1-1/4" from Net Unit Height. For 7-0 prehung, add 4" to Net Unit Height. For 8-0 prehung, add 16" to Net Unit Height.*

## DOOR HANDING

### IN SWING

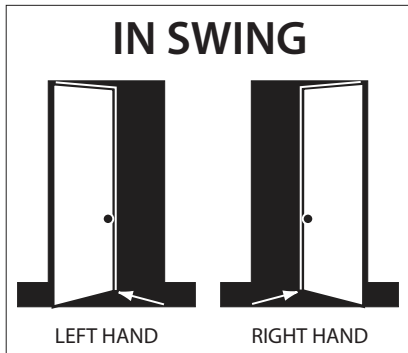

### OUT SWING

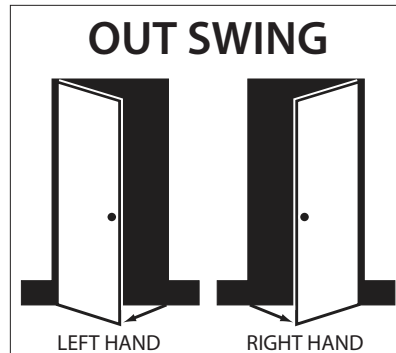

### SINGLE DOORS

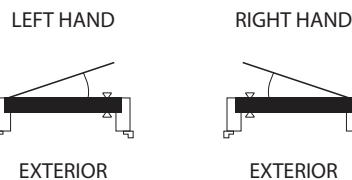

### SINGLE DOORS

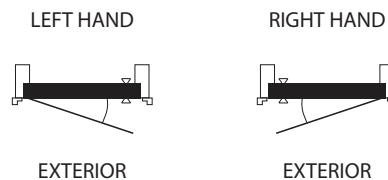

### DOUBLE DOORS

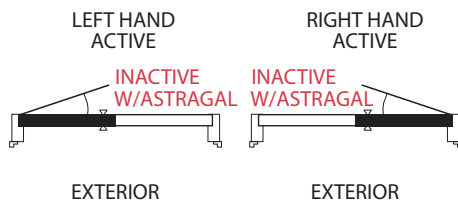

### DOUBLE DOORS

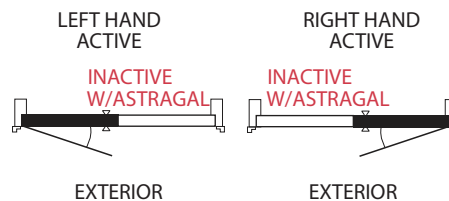

# PREHUNG NET UNIT MEASUREMENTS

\*Add 5/8" to any Net Unit Width and 3/8" to any Net Unit Height **IF IT IS AN OUTSWING** with the ALUMINUM NAILING FLANGE.

NET UNIT WIDTHS*							NET UNIT HEIGHTS		
DOOR WIDTH	NET SLAB SIZE	NET UNIT WIDTH	PLUS 1 EACH 12" SIDELITE	PLUS 2 EACH 12" SIDELITES	PLUS 1 EACH 14" SIDELITE	PLUS 2 EACH 14" SIDELITES	FIXED OR ADJ INSWING SILL	BUMPER OUTSWING SILL	ADA LOW-PRO IN/OUT SWING SILL
2-0 x 6-8	23-3/4" x 79"	25-1/2"	38-7/8"	52-1/4"	40-7/8"	56-1/4"	81-3/4"	80-1/2"	81"
2-4 x 6-8	27-3/4" x 79"	29-1/2"	42-7/8"	56-1/4"	44-7/8"	60-1/4"	81-3/4"	80-1/2"	81"
2-6 x 6-8	29-3/4" x 79"	31-1/2"	44-7/8"	58-1/4"	46-7/8"	62-1/4"	81-3/4"	80-1/2"	81"
2-8 x 6-8	31-3/4" x 79"	33-1/2"	46-7/8"	60-1/4"	48-7/8"	64-1/4"	81-3/4"	80-1/2"	81"
2-10 x 6-8	33-3/4" x 79"	35-1/2"	48-7/8"	62-1/4"	50-7/8"	66-1/4"	81-3/4"	80-1/2"	81"
3-0 x 6-8	35-3/4" x 79"	37-1/2"	50-7/8"	64-1/4"	52-7/8"	68-1/4"	81-3/4"	80-1/2"	81"
3-6 x 6-8	41-3/4" x 79"	43-1/2"	56-7/8"	70-1/4"	58-7/8"	74-1/4"	81-3/4"	80-1/2"	81"
4-0 x 6-8	47-3/4" x 79"	49-1/2"	62-7/8"	76-1/4"	64-7/8"	80-1/4"	81-3/4"	80-1/2"	81"
4-0 x 6-8 DBL	--	50"	63-3/8"	76-3/4"	65-3/8"	80-3/4"	81-3/4"	80-1/2"	81"
4-8 x 6-8 DBL	--	58"	71-3/8"	84-3/4"	73-3/8"	88-3/4"	81-3/4"	80-1/2"	81"
5-0 x 6-8 DBL	--	62"	75-3/8"	88-3/4"	77-3/8"	92-3/4"	81-3/4"	80-1/2"	81"
5-4 x 6-8 DBL	--	66"	79-3/8"	92-3/4"	81-3/8"	96-3/4"	81-3/4"	80-1/2"	81"
5-8 x 6-8 DBL	--	70"	83-3/8"	96-3/4"	85-3/8"	100-3/4"	81-3/4"	80-1/2"	81"
6-0 x 6-8 DBL	--	74"	87-3/8"	100-3/4"	89-3/8"	104-3/4"	81-3/4"	80-1/2"	81"
7-0 x 6-8 DBL	--	86"	99-3/8"	112-3/4"	101-3/8"	116-3/4"	81-3/4"	80-1/2"	81"
8-0 x 6-8 DBL	--	98"	111-3/8"	124-3/4"	113-3/8"	128-3/4"	81-3/4"	80-1/2"	81"
2-6 x 7-0	29-3/4" x 83"	31-1/2"	44-7/8"	58-1/4"	46-7/8"	62-1/4"	85-3/4"	84-1/2"	85"
2-8 x 7-0	31-3/4" x 83"	33-1/2"	46-7/8"	60-1/4"	48-7/8"	64-1/4"	85-3/4"	84-1/2"	85"
3-0 x 7-0	35-3/4" x 83"	37-1/2"	50-7/8"	64-1/4"	52-7/8"	68-1/4"	85-3/4"	84-1/2"	85"
5-0 x 7-0 DBL	--	62"	75-3/8"	88-3/4"	77-3/8"	92-3/4"	85-3/4"	84-1/2"	85"
5-4 x 7-0 DBL	--	66"	79-3/8"	92-3/4"	81-3/8"	96-3/4"	85-3/4"	84-1/2"	85"
6-0 x 7-0 DBL	--	74"	87-3/8"	100-3/4"	89-3/8"	104-3/4"	85-3/4"	84-1/2"	85"
2-6 x 8-0	29-3/4" x 95"	31-1/2"	44-7/8"	58-1/4"	46-7/8"	62-1/4"	97-3/4"	96-1/2"	97"
2-8 x 8-0	31-3/4" x 95"	33-1/2"	46-7/8"	60-1/4"	48-7/8"	64-1/4"	97-3/4"	96-1/2"	97"
3-0 x 8-0	35-3/4" x 95"	37-1/2"	50-7/8"	64-1/4"	52-7/8"	68-1/4"	97-3/4"	96-1/2"	97"
3-6 x 8-0	41-3/4" x 95"	43-1/2"	56-7/8"	70-1/4"	58-7/8"	74-1/4"	97-3/4"	96-1/2"	97"
5-0 x 8-0 DBL	--	62"	75-3/8"	88-3/4"	77-3/8"	92-3/4"	97-3/4"	96-1/2"	97"
5-4 X 8-0 DBL	--	66"	79-3/8"	92-3/4"	81-3/8"	96-3/4"	97-3/4"	96-1/2"	97"
6-0 x 8-0 DBL	--	74"	87-3/8"	100-3/4"	89-3/8"	104-3/4"	97-3/4"	96-1/2"	97"
7-0 x 8-0 DBL	--	86"	99-3/8"	112-3/4"	101-3/8"	116-3/4"	97-3/4"	96-1/2"	97"
2-6 x EZ FIT	28-1/4" x 76-3/4"	30"	N/A	N/A	N/A	N/A	79-1/2"	78-1/4"	78-3/4"
3-0 x EZ FIT	34-1/4" x 76-3/4"	36"	N/A	N/A	N/A	N/A	79-1/2"	78-1/4"	78-3/4"
5-0 x EZ DBL	--	59"	N/A	N/A	N/A	N/A	79-1/2"	78-1/4"	78-3/4"
6-0 x EZ DBL	--	71"	N/A	N/A	N/A	N/A	79-1/2"	78-1/4"	78-3/4"

### Standard Paint Colors

Codel offers a variety of paint colors to compliment our Smooth, Textured and Contemporary Classic doors.



### Standard Textured Fiberglass Stain Colors

Have Codel stain your textured fiberglass door today! We have an array of beautiful stain colors to choose from.



### Fir Grain Stain Colors

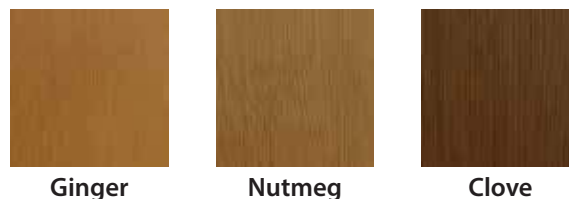

Available on Fir-Grain Doors (See pages 30 - 32, & 54-57).

**Why doesn't the color on my product look exactly like it does in the catalog or website?**

*Due to the limitations of photography, there is no guarantee that your product's colors will have the same appearance as they do in print or online. We always recommend you see an actual sample before deciding on a color choice. Contact a Codel dealer to request a color chip sample.*