

PREMIUM EXTERIOR DOORS

CODEL
DOORS
Fiberglass & Steel





SF8SDL1P doors with Carbon paint.



CODEL DOORS

Complete & Ontime DELivery!

Featuring Fiberglass and Steel entry doors.

Table of Contents

The CODEL Difference 4-5
 Door Skins and Textures 6-7
 New Products..... 8
 Design Ideas 9-13

Contemporary Classics

6-8 & 7-0 Contemporary Classics Collection..... 14-15
 8-0 Contemporary Classics Collection 16-17
 Decorative Contemporary Classics Collection..... 18
 Engraved Contemporary Classics & Textured Fiberglass Teak 19

Craftsman

6-8 Standard Craftsman Collection..... 20-21
 6-8 & 8-0 Smooth Fiberglass Heritage Craftsman Collection 22-25
 6-8 & 8-0 Fir-Grain Fiberglass Heritage Craftsman Collection 26-29

Commodity Doors

Smooth Fiberglass Standard Collection..... 30-33
 Smooth Fiberglass Flush-Glazed Collection 34-35
 Smooth Fiberglass Direct Glazed Contemporary Collection..... 36-37
 Smooth Fiberglass Flush-Glazed Contemporary Collection..... 38
 Oak Grain Textured Fiberglass Standard Collection 39-41
 Oak Grain Textured Fiberglass Flush-Glazed Collection..... 42-43
 Fir Grain Textured Fiberglass Direct Glazed Contemporary..... 44-45
 Fir Grain Textured Fiberglass Collection..... 46
 Premium Shaker Fiberglass Collection 47-51
 Rustic Fiberglass Collection 52-53
 Steel Standard Collection 54-55
 90-Minute "Fast-Frame" Fire Doors..... 56-57
 Single-Hinged Inswing Fiberglass Patio Doors 58-59
 Traditional Patio Doors..... 60-61
 "Retro" Double Doors..... 62
 Swinging Patio 63

Decorative Collections

NEW Eastmont 64-65	Eloquence 82-83
NEW Perimeter..... 66-67	Floret..... 84-85
NEW Royston 68-69	Harlow 86-87
NEW Sable 70-71	Maren..... 88-89
Adelaide..... 72-73	Modena..... 90-91
Artisan 74-75	Narrows..... 92-93
Brentwood 76-77	Niagara 94-95
Canterbury..... 78-79	Satin Etch..... 96-97
Chord 80-81	Waterton..... 98-99

Obscure Glass Options 100
 Specialty Glass Options..... 101
 Split Finish..... 102-103
 WeatherGuard Frame..... 104
 Adjustable Sill Pan & Jamb Options..... 105
 Sills..... 106
 Hinges..... 107
 Hoppe MultiPoint Hardware 108
 Rockwell MultiPoint..... 109-110
 Contemporary Door Pulls..... 111
 Codel Door Configurations..... 112-113
 Decorative Transom Sizes & Door Handing 114
 Prehung Net Unit Measurements..... 115

Cover Photo: Heritage SFHER-303 with (x2) SFHER-280 sidelites.

Style & Beauty

Traditional to Classic, Craftsman to Contemporary. Codel offers a wide selection of styles and collections to best suit your own design.



Secure

MultiPoint lock hardware options or a heavy duty steel plate to reinforce the latch jamb against break-in force, offers more security and peace of mind.



Heavy Duty Steel Plate

Reinforces jamb against break-in force.



MultiPoint Lock Hardware

(Optional)

Increases resistance against break-in force.

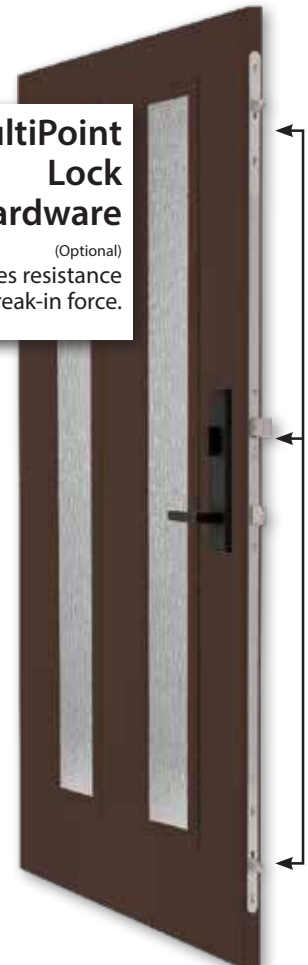

Efficient

Codel doors provide more insulation value than wood doors and are more efficient than older, worn-out, drafty doors. Low-E and Argon is standard in our decorative glass doors.



Low-Emissivity (Low-E) and Argon is standard in our decorative glass for improved energy performance. Low-E is standard on all of our Commodity doors with glass.

Thermal Performance values established in accordance with ETC Laboratories (NFRC) Simulation Report

	R value	U value	SHGC value
Fiberglass Full Panel door unit w/no glass	6.25	0.16	0.00
Fiberglass door unit w/1/2 Low-E Glass	4.17	0.24	0.16
Fiberglass door unit w/3/4 Low-E Glass	3.85	0.26	0.21
Fiberglass door unit w/Full Low-E Glass	3.45	0.29	0.28
Fiberglass door unit w/1/2 Low-E Mini Blind Glass	3.57	0.28	0.11
Fiberglass door unit w/3/4 Low-E Mini Blind Glass (blind up)	3.33	0.30	0.18
Fiberglass door unit w/Full Low-E Mini Blind Glass	2.94	0.34	0.22
Fiberglass door unit w/1/4 Low-E Decorative Glass	5.00	0.20	0.07
Fiberglass door unit w/1/2 Low-E Decorative Glass	4.55	0.22	0.13
Fiberglass door unit w/3/4 Low-E Decorative Glass	4.17	0.24	0.17
Fiberglass door unit w/Full Low-E Decorative Glass	3.85	0.26	0.23
Fiberglass door unit w/Full Flush Glazed Low-E Glass	3.70	0.27	0.32
Fiberglass door unit w/Full Flush Glazed Low-E Mini Blind Glass	3.03	0.33	0.22

Quality Features

WeatherGuard Jamb

(Optional)

Composite jamb resists moisture, rotting, splitting and termites.



LIMITED LIFE TIME WARRANTY ALL Codel fiberglass doors come with a **LIFETIME LIMITED WARRANTY**

Corner Seal

Added protection against water and air infiltration.



Commercial-Grade Ball Bearing Hinges

Designed to operate smoother and longer. Non-ferrous now standard on all outswing doors to prevent rusting.



Not Available in Wood-Edge or Steel Doors.

Smooth Fiberglass **SF**



See pages 30-38 for Smooth Fiberglass doors.

"Oak" Textured Fiberglass **TF**

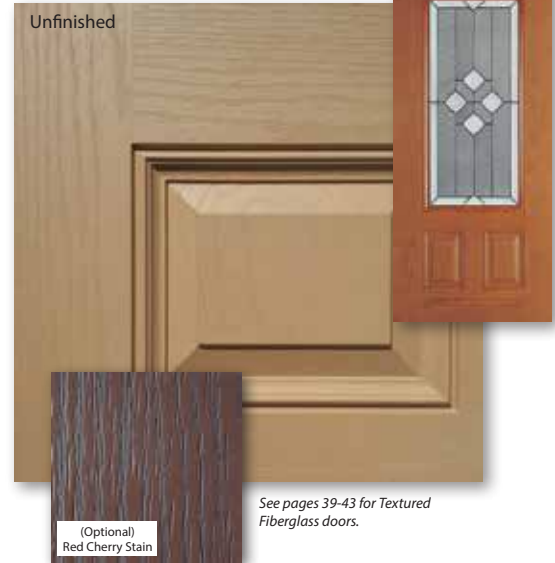

See pages 39-43 for Textured Fiberglass doors.

Premium Shaker
Smooth Fiberglass **SF** or Fir Grain **FG**



See page 46-51 for Smooth & Fir Grain Fiberglass doors.

Heritage Craftsman
Fir-Grain **FG** or Smooth Fiberglass **SF**



See pages 22-29 for Heritage Craftsman Collection.

Premium Smooth
Smooth Fiberglass **SF**



See page 30 for Smooth Fiberglass doors.

CODEL
COATINGS



Paint or Stain, we've got you covered!

Steel S

Unfinished



(Optional)
Pacific Paint

See page 54-55 for Steel doors.

"Teak" Textured Fiberglass

Unfinished

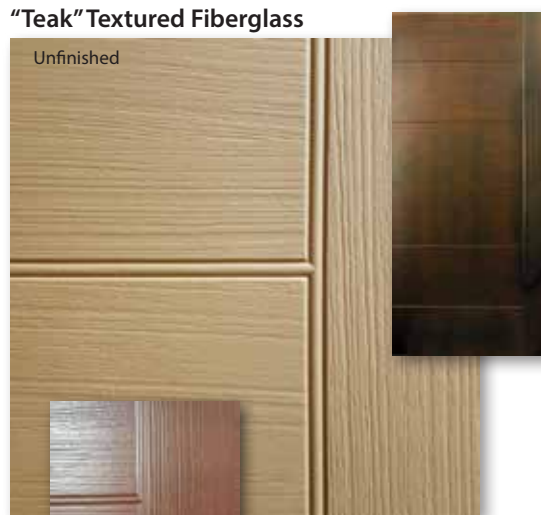

(Optional)
Mahogany Stain

See page 19 for Teak door.

"Rustic" Textured Fiberglass RF

Unfinished

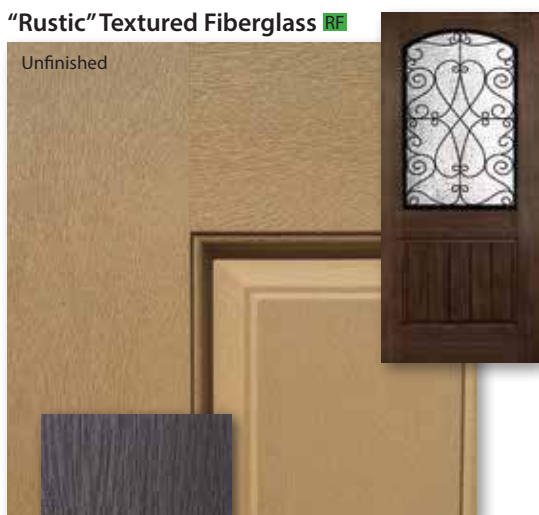

(Optional)
Walnut Stain

See pages 52-53 for Rustic Collection.

Flush Cherry Engraved

Unfinished

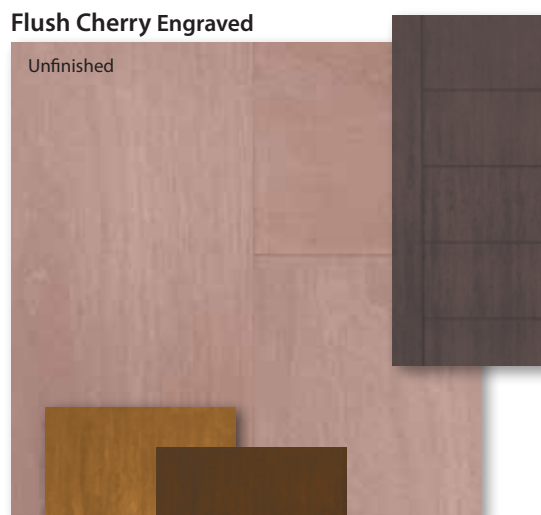

(Optional)
Ginger Stain

(Optional)
Clove Stain

See page 19 for Flush Cherry Engraved doors.

Professional factory painting or staining
for a beautiful finish.
(See back of brochure for additional colors.)

NEW
**6/8 3-Equal Smooth
 Fiberglass and Fir-Grain
 Shaker Doors**

See pages 30 & 46.



SF
 SF3PESHK

FG
 FG3PESHK

FG
 FGSL

NEW
**Direct Glazed
 Contemporary
 Collection**

See pages 36-37 & 44-45.



SF20D 6/8 & 8/0
 (Available in FG also)

SF20D1P 6/8 & 8/0
 (Brushed Smooth Finish)

NEW
**6/8
 3/4 2-Panel Oak
 Textured Door**

See page 39.



TF2PL

NEW
Low-E Glass is NOW Standard on ALL Doors

See pages
 30-37, 39-43
 & 55.



NEW
**8/0 1-Panel & 2-Panel
 Smooth Fiberglass
 Shaker Doors**

See page 30-31.



SF
 SF1PSHK80

SF
 SF2PSHK80

NEW
Decorative Glass and Textured Glass Options

See pages 64-71.



Sable

Eastmont

Perimeter

Royston

NEW
**Non-ferrous
 hinges are now
 standard on
 outswing doors**

See page 107.





Modern Contemporary

Featuring simple forms and geometric lines, contemporary houses are designed to fit today's lifestyles. The style encompasses a variety of distinctive elements, often featuring unconventional shapes and innovative details. Contemporary homes are often much warmer in design than modern versions. In general, contemporary homes try to bring the interior and exterior together.



*Satin Etch
CON-2236
(See page 16.)*



*Chord
CHO-460
(See page 80.)*

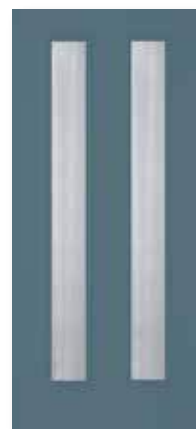

*Sable
CON-7642 with
Codel Coatings
Denim Paint
(See page 15.)*



*SF20F4L
Flush-Glazed
Contemporary
with applied
Aluminum
Mullion Bars
Satin Etch
(See page 38.)*



Modern Farmhouse

A balanced blend of modern and rustic, the Modern Farmhouse style continues to be a rising trend. We paired some of our favorite door and glass options that intelligently mix modern and traditional.

*FG3ESHK
(See page 46.)*



*Eastmont
EAS-4401P with Codel
Coatings Fremont Paint
(See page 64.)*



*Adelaide
FGHADE-200
(See page 27.)*



*SF6SDL1P
(See page 32.)*



Contemporary Northwest

Contemporary homes reflect the architecture and design of today. They represent smart design and curb appeal. We selected several doors that we believe represent the ethos of now and can be loved forever.



*Clear
CON-2235 with
Codel Coatings
Proctor Paint
(See page 14.)*



*Sable
CON-7642
(See page 15.)*



*Chord
CHO-460
(See page 80.)*



*SF20F4L
Flush-Glazed
Contemporary
with applied
Aluminum
Mullion Bars
Satin Etch
(See page 38.)*



Craftsman

Craftsman homes emphasize hand-worked touches and beautiful detailing. Popularized at the turn of the 20th Century, it remains a popular design aesthetic. We have recommended several door and glass options that give you the beautiful detailing a craftsman home requires.



*Artisan
ART-4301P
(See page 74.)*



*Narrows
NAR-460 with
Codel Coatings
Cougar Paint
(See page 92.)*



*Adelaide
SFHADE-200
(See page 23.)*



*Waterton
WAT-64
(See page 98.)*



*Beveled Glass
FLS-200 with
Codel Coatings
Artichoke Paint
(See page 21.)*



Traditional

Traditional homes are comforting and classic. Their interiors are calm, orderly and predictable. Everything matches and is consistent. We suggest these doors for completing the look in a traditional home style and décor.



*Floret
FLO-1842OV
(See page 85.)*



*Adelaide
ADE-4401P
(See page 72.)*



*Niagara
NIA-430 with
Codel Coatings
Ballard Paint
(See page 94.)*



*Eloquence
ELO-440
(See page 82.)*



*Canterbury
CAN-460
(See page 78.)*

**CODEL
DOORS**



**6/8 & 7/0
Contemporary Classics**

(Textured Fiberglass available upon request.
Contact your Codel Rep. for details.)

*CON-2285 door and (2) CON-865SL sidelites
with Clear glass and Bright paint.*



Daylight Glass Size 21" x 2-1/2"

SF

CON-2235
6-8 (28 210 30 36)
7-0 (28 30 36)



Daylight Glass Size 21" x 7"

SF

CON-2285
6-8 (28 210 30 36)
7-0 (28 30 36)

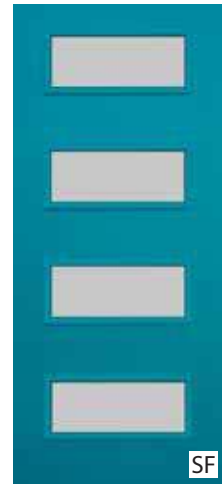

Daylight Glass Size 21" x 7"

SF

CON-2284
6-8 (28 210 30 36)
7-0 (28 30 36)

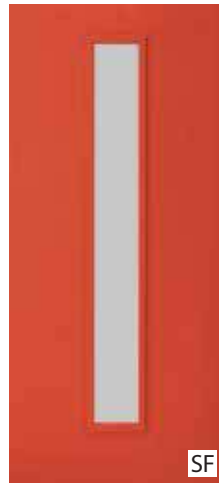

Daylight Glass Size 6" x 63"

SF

CON-764C
6-8 (28 210 30 36)
7-0 (28 30 36)



Daylight Glass Size 6" x 63"

SF

CON-764S
6-8 (28 210 30 36)
7-0 (28 30 36)



Daylight Glass Size 6" x 63"

SF

CON-764SL
(12" & 14")



Daylight Glass Size 7" x 5"

SF

CON-865C
6-8 (28 210 30 36)
7-0 (28 30 36)



Daylight Glass Size 7" x 5"

SF

CON-865S
6-8 (28 210 30 36)
7-0 (28 30 36)

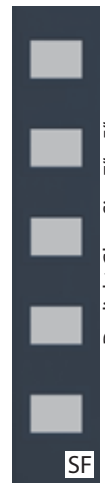

Daylight Glass Size 7" x 5"

SF

CON-865SL
(14")

SF Smooth Fiberglass

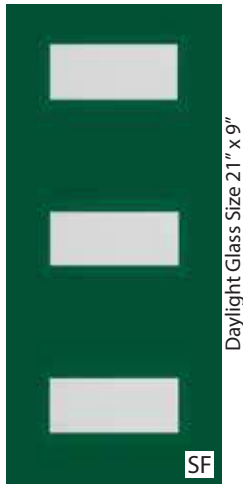

Daylight Glass Size 21" x 9"

SF

CON-22103
6-8 (28 210 30 36)
7-0 (28 30 36)



Daylight Glass Size 21" x 9"

SF

CON-22104
6-8 (28 210 30 36)
7-0 (28 30 36)



Daylight Glass Size 21" x 14-1/4"

SF

CON-22153
6-8 (28 210 30 36)
7-0 (28 30 36)



Daylight Glass Size 21" x 2-1/2" (4) & 21" x 14-1/4" (1)

SF

CON-221534
6-8 (28 210 30 36)
7-0 (28 30 36)



Daylight Glass Size 6" x 63" (x 2)

SF

CON-7642
6-8 (28 210 30 36)
7-0 (28 30 36)

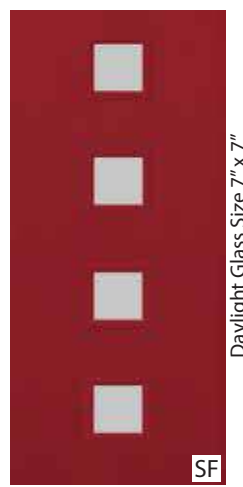

Daylight Glass Size 7" x 7"

SF

CON-884C
6-8 (28 210 30 36)
7-0 (28 30 36)



Daylight Glass Size 7" x 7"

SF

CON-884S
6-8 (28 210 30 36)
7-0 (28 30 36)



Daylight Glass Size 7" x 7"

SF

CON-884SL
(14")

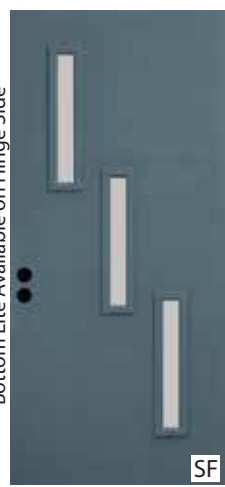

Bottom Lite Available on Hinge Side

SF

CON-3223
6-8 (28 210 30 36)
7-0 (28 30 36)



Daylight Glass Size 7" x 7"

SF

CON-884D
6-8 (28 210 30 36)
7-0 (28 30 36)

Stock Glass Options



Clear/Low-E



Sable



Satin Etch



Chord



Contemporary Low Profile Lite Frame

Paint Options

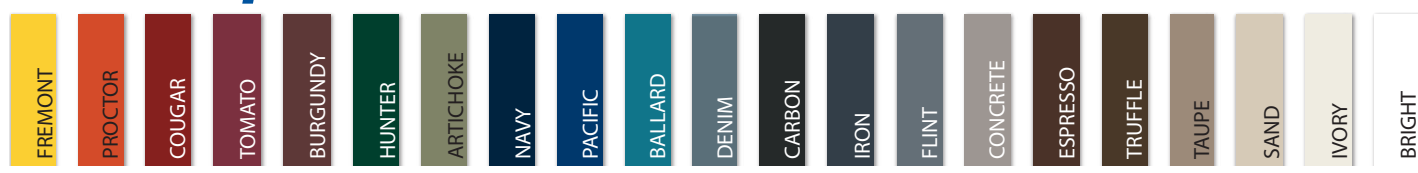

FREMONT

PROCTOR

COUGAR

TOMATO

BURGUNDY

HUNTER

ARTICHOKE

NAVY

PACIFIC

BALLARD

DENIM

CARBON

IRON

FLINT

CONCRETE

ESPRESSO

TRUFFLE

TAUPE

SAND

IVORY

BRIGHT

Color samples are reproduced as close as possible, actual color may vary.

**CODEL
DOORS**

**8/0
Contemporary Classics
(Smooth Fiberglass Only)**



Contemporary Classics CON-221535 door with Flint paint.



CON-2236
(28 30 36)

Daylight Glass Size 21" x 2-1/2"

SF



CON-2286
(28 30 36)

Daylight Glass Size 21" x 7"

SF



CON-221535
(28 30 36)

Daylight Glass Size 21" x 2-1/2" (5) & 21" x 14-1/4" (1)

SF

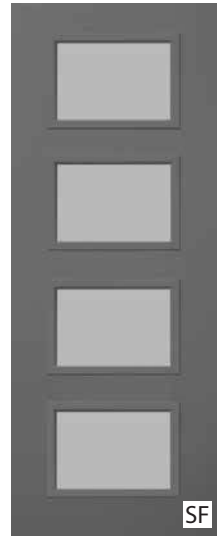

CON-22154
(28 30 36)

Daylight Glass Size 21" x 14-1/4"

SF

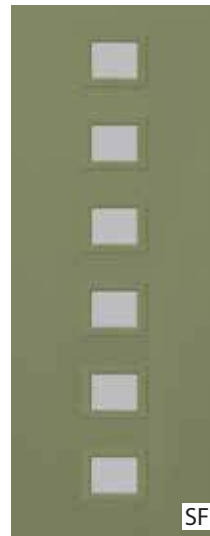

CON-866C
(28 30 36)

Daylight Glass Size 7" x 5"

SF



CON-866S
(28 30 36)

Daylight Glass Size 7" x 5"

SF

SF Smooth Fiberglass

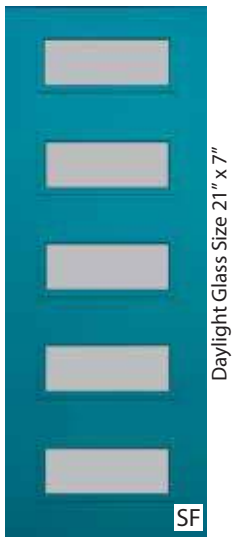

CON-2285
(28 30 36)



CON-2210480
(28 30 36)



CON-2210580
(28 30 36)



CON-885C
(28 30 36)



CON-885S
(28 30 36)



CON-885SL
(14")



CON-866SL
(14")



CON-885D
(28 30 36)



Contemporary
Low Profile
Lite Frame

Stock Glass Options



Clear/Low-E



Sable



Satin Etch



Chord

Paint Options



FREMONT



PROCTOR



COUGAR



TOMATO



BURGUNDY



HUNTER



ARTICHOKE

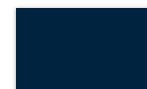

NAVY



PACIFIC



BALLARD



DENIM



CARBON



IRON



FLINT



CONCRETE



ESPRESSO



TRUFFLE



TAUPE



SAND

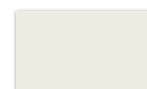

IVORY



BRIGHT

Color samples are reproduced as close as possible, actual color may vary.

Decorative Contemporary Classics



ART-22153
6-8 (28 210 30 36)
7-0 (28 30 36)

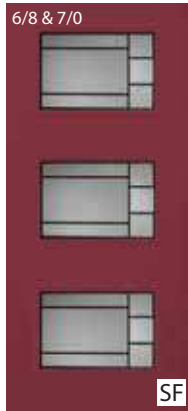

MOD-22153
6-8 (28 210 30 36)
7-0 (28 30 36)



HAR-22153
6-8 (28 210 30 36)
7-0 (28 30 36)

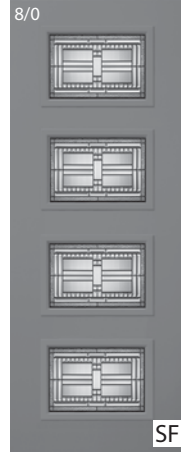

ART-22154
(28 30 36)



MOD-22154
(28 30 36)

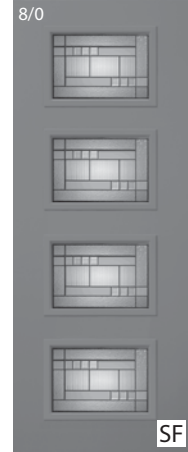

HAR-22154
(28 30 36)

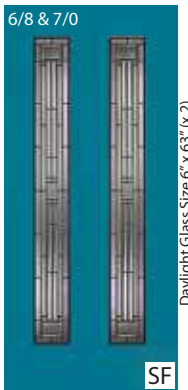

ART-7642
6-8 (28 210 30 36)
7-0 (28 30 36)

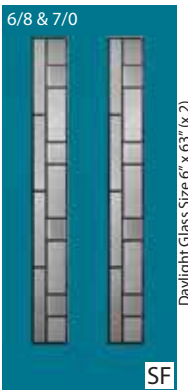

MOD-7642
6-8 (28 210 30 36)
7-0 (28 30 36)

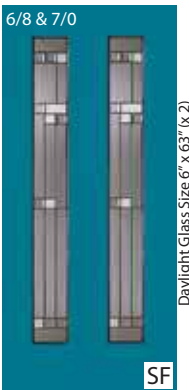

HAR-7642
6-8 (28 210 30 36)
7-0 (28 30 36)

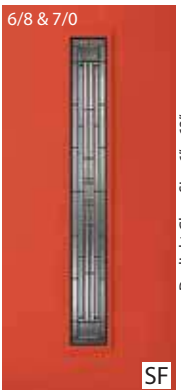

ART-764C
6-8 (28 210 30 36)
7-0 (28 30 36)



MOD-764C
6-8 (28 210 30 36)
7-0 (28 30 36)



HAR-764C
6-8 (28 210 30 36)
7-0 (28 30 36)

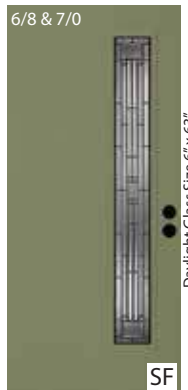

ART-764S
6-8 (28 210 30 36)
7-0 (28 30 36)



MOD-764S
6-8 (28 210 30 36)
7-0 (28 30 36)

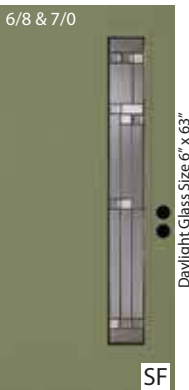

HAR-764S
6-8 (28 210 30 36)
7-0 (28 30 36)



ART-764SL
6-8 (12" & 14")
7-0 (12" & 14")

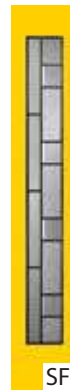

MOD-764SL
6-8 (12" & 14")
7-0 (12" & 14")



HAR-764SL
6-8 (12" & 14")
7-0 (12" & 14")



Contemporary Low Profile Lite Frame

HAR-764S with Artichoke paint.

Paint Options

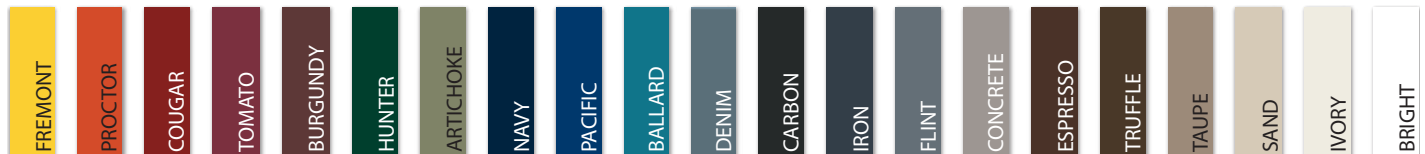

Color samples are reproduced as close as possible, actual color may vary.

Flush Cherry Engraved Contemporary Classics

Our high-quality fiberglass door designs complement the architectural style of contemporary homes. These doors contain engravings for a striking front entrance.



Flush Cherry Engraved Contemporary Classics CON-C501 door. Stain shown is not Codel Coatings.



CON-C499
6-8 (30)
8-0 (30 36)



CON-C498
6-8 (14")
8-0 (14")



CON-C500
6-8 (30)
8-0 (30 36)



CON-C501
6-8 (30)



CON-C551
8-0 (30 36)



*Unfinished
Flush Cherry*

Doors shown here are stained with Ginger stain. (See back cover for additional stain options.)



TFT door. Stain shown is not Codel Coatings.

Textured Fiberglass Teak Contemporary Classics



TFT
6-8 (30)



Unfinished Teak
(See back cover for Stain options.)

**CODEL
DOORS**



6/8 Standard Craftsman

C-21P Craftsman Shelf



(Optional)

SF
TF

FLS-200 door with Denim paint. Shown with optional dentil shelf.

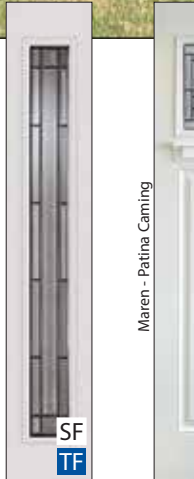
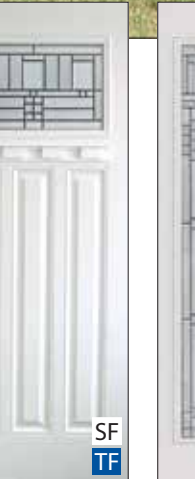
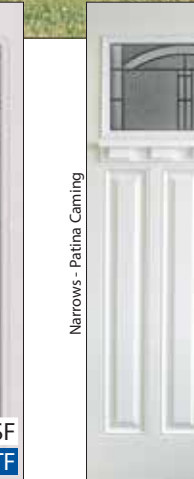
<p>Adelaide - Patina Caming</p>		<p>Maren - Patina Caming</p>		<p>Narrows - Patina Caming</p>		<p>Waterton - Patina Caming</p>	
<p>ADE-200 (30)</p>	<p>ADE-160 (12" & 14")</p>	<p>MAR-200 (30)</p>	<p>MAR-160 (12" & 14")</p>	<p>NAR-200 (30)</p>	<p>NAR-160 (12" & 14")</p>	<p>WAT-200 (30)</p>	<p>WAT-160 (12" & 14")</p>

SF Smooth Fiberglass TF Textured Fiberglass Doors shown with optional C-21P shelf.



Craftsman Transom



■ FLF-6312 / FLF-6712 / FLF-7212

Refer to Page 106 for Transom Size Information.
 ■ Extended Leadtime Required.

6/8 & 8/0 Craftsman 4-Panel Collection

Patina, Bevel Clear I.G.



FLF-64
FLF-6480
(30)

Patina



SPR-64
SPR-6480
(30)

No Matching Sidelite Available

**NO
Door Shelf
Available**

**CODEL
DOORS**

SFHADE-200 door with Flint paint.
Shown with optional dentil shelf.

6/8 Smooth Fiberglass Heritage Craftsman

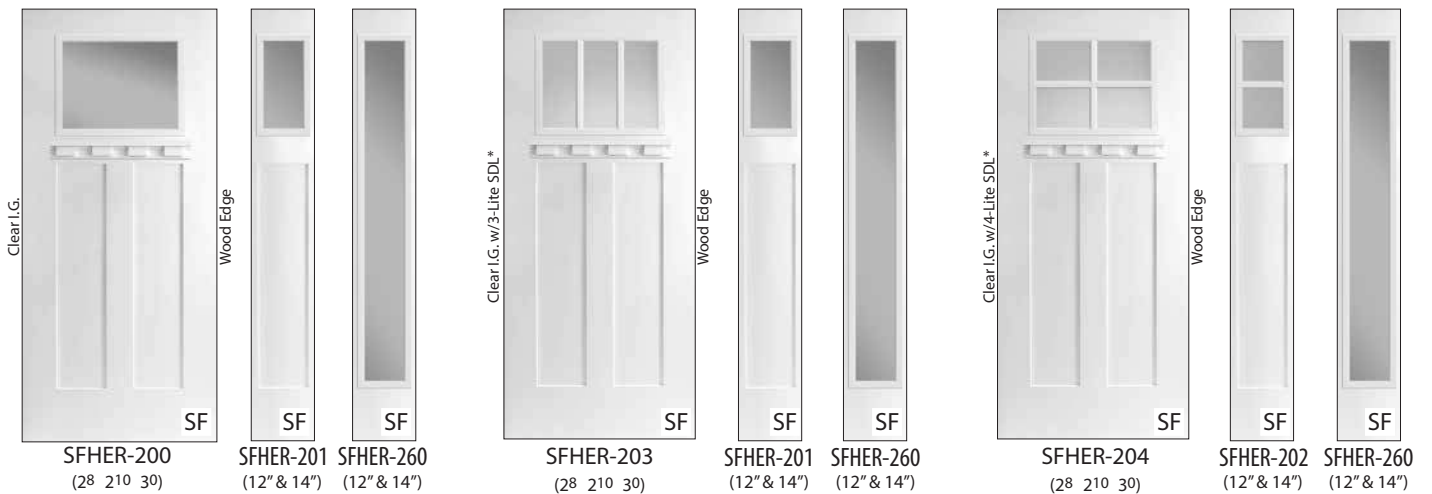

SF Smooth Fiberglass - *SDL: Simulated Divided Lite - Additional Obscure Glass Options Available, See Page 100. - Doors shown with optional C21P Craftsman Shelf.

6/8 Smooth Fiberglass Heritage Craftsman

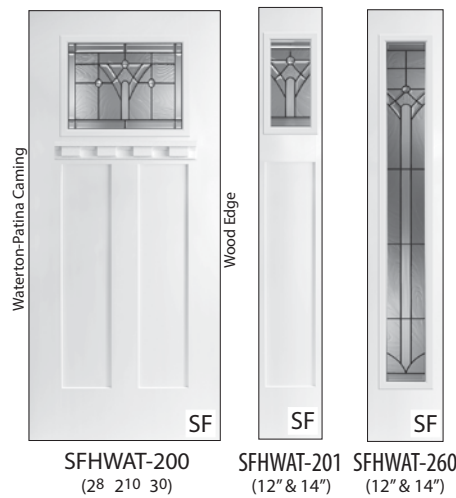
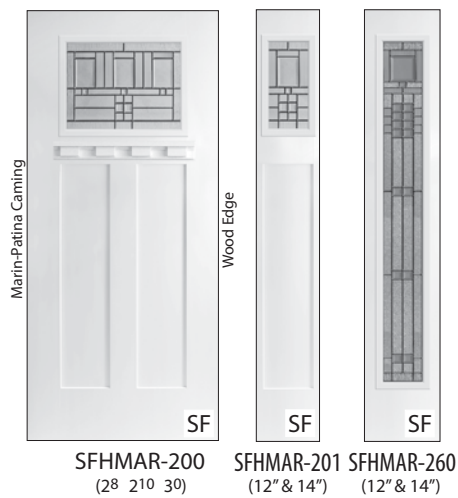
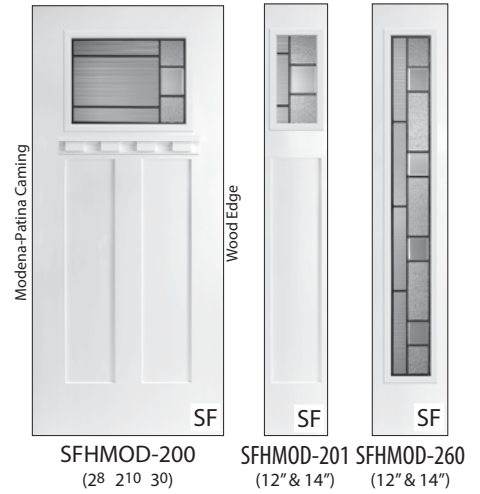
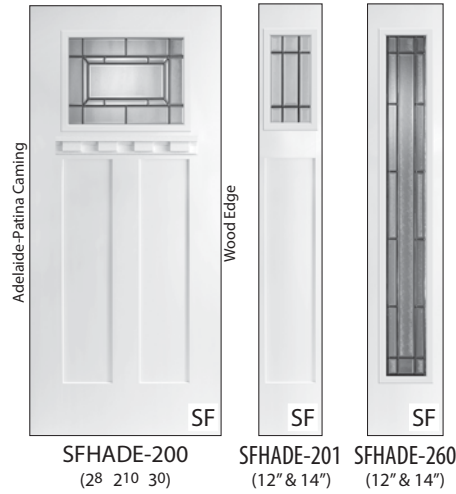
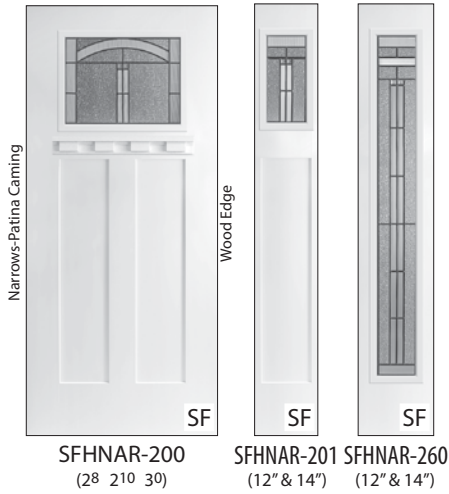
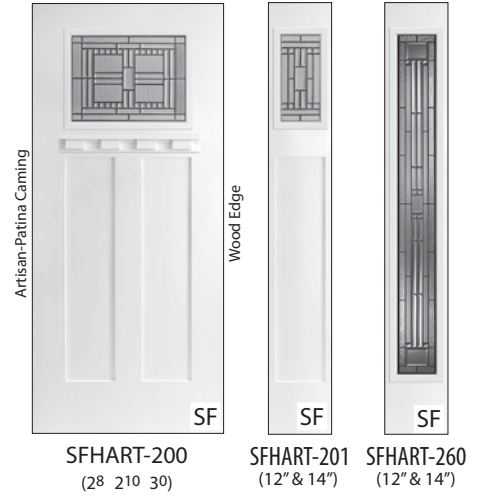
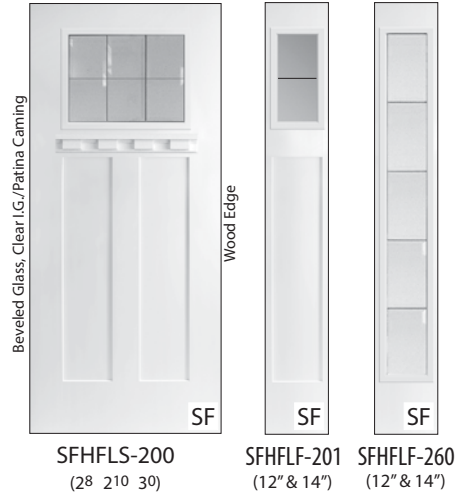
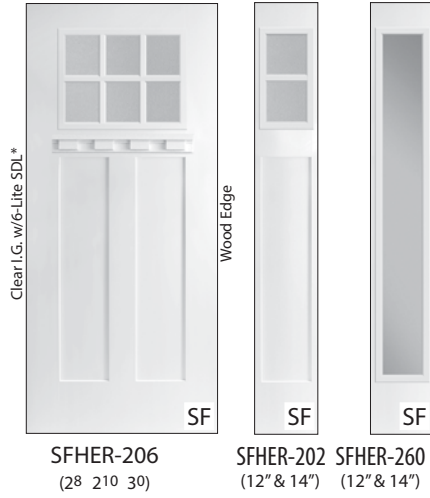

Heritage Lite Kit Frame

Lite kit frame features clean, classic lines, and is reglazeable.

Simulated Divided Lite

Simulated divided lite bars are 5/16" thick x 1-1/8" wide.

C-21P Craftsman Shelf

(Optional)



Color samples are reproduced as close as possible, actual color may vary.

8/0 Smooth Fiberglass Heritage Craftsman





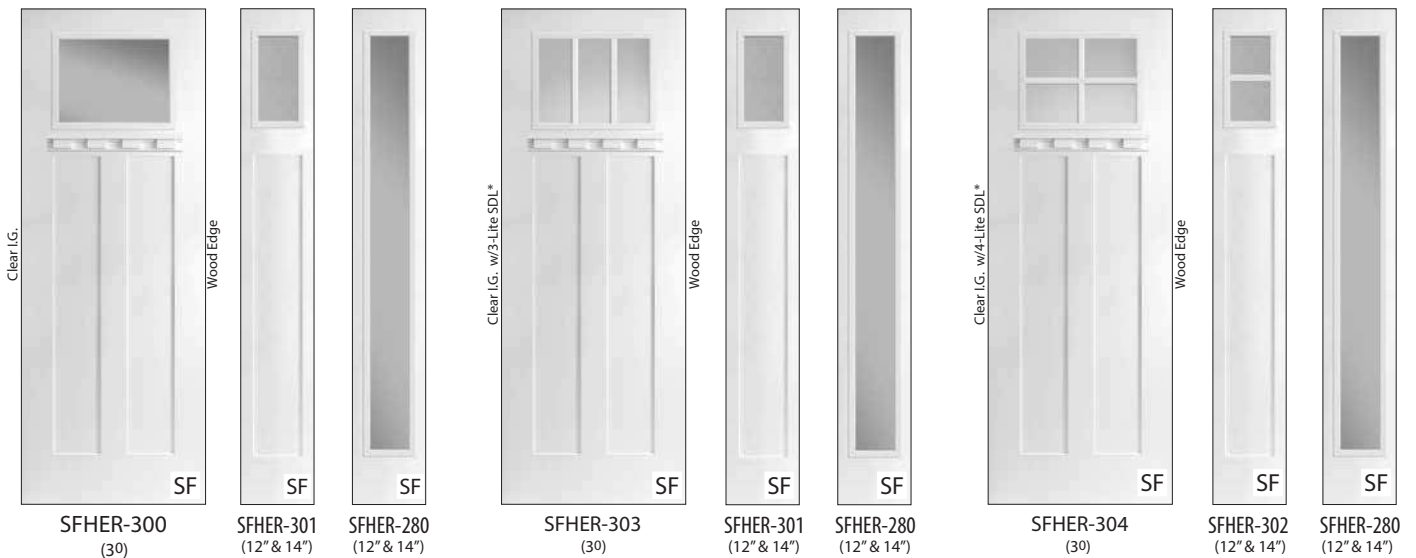

SFHER-300 door with Cougar paint. Shown with optional dentil shelf.



SF Smooth Fiberglass - *SDL: Simulated Divided Lite - Additional Obscure Glass Options Available, See Page 100. - Doors shown with optional C21P Craftsman Shelf.

8/0 Smooth Fiberglass Heritage Craftsman

<p>Clear LG. w/6-Lite SDL*</p>  <p>SFHER-306 (30)</p>	<p>Wood Edge</p>  <p>SFHER-302 (12" & 14")</p>	 <p>SFHER-280 (12" & 14")</p>	<p>Beveled Glass, Clear LG./Patina Caming</p>  <p>SFHFLS-300 (30)</p>	<p>Wood Edge</p>  <p>SFHFL-302 (12" & 14")</p>	<p>Artisan - Patina Caming</p>  <p>SFHART-300 (30)</p>	<p>Wood Edge</p>  <p>SFHART-301 (12" & 14")</p>	 <p>SFHART-280 (12" & 14")</p>
<p>Narrows-Patina Caming</p>  <p>SFHNAR-300 (30)</p>	<p>Wood Edge</p>  <p>SFHNAR-301 (12" & 14")</p>	<p>Adelaide - Patina Caming</p>  <p>SFHADE-300 (30)</p>	<p>Wood Edge</p>  <p>SFHADE-301 (12" & 14")</p>	 <p>SFHADE-280 (12" & 14")</p>	<p>Modena - Patina Caming</p>  <p>SFHMOD-300 (30)</p>	<p>Wood Edge</p>  <p>SFHMOD-301 (12" & 14")</p>	 <p>SFHMOD-280 (12" & 14")</p>
<p>Maren-Patina Caming</p>  <p>SFHMAR-300 (30)</p>	<p>Wood Edge</p>  <p>SFHMAR-301 (12" & 14")</p>	<p>Waterton - Patina Caming</p>  <p>SFHWAT-300 (30)</p>	<p>Wood Edge</p>  <p>SFHWAT-301 (12" & 14")</p>	 <p>SFHWAT-280 (12" & 14")</p>	<div style="display: flex; justify-content: space-between;"> <div style="width: 45%;"> <p>Heritage Lite Kit Frame</p>  <p>Lite kit frame features clean, classic lines, and is reglazeable.</p> </div> <div style="width: 45%;"> <p>Simulated Divided Lite</p>  <p>Simulated divided lite bars are 5/16" thick x 1-1/8" wide.</p> </div> </div> <div style="text-align: center; margin-top: 10px;"> <p>C-21P Craftsman Shelf</p>  <p>(Optional)</p> </div>		



Color samples are reproduced as close as possible, actual color may vary.

6/8 Fir-Grain Textured Fiberglass Heritage Craftsman

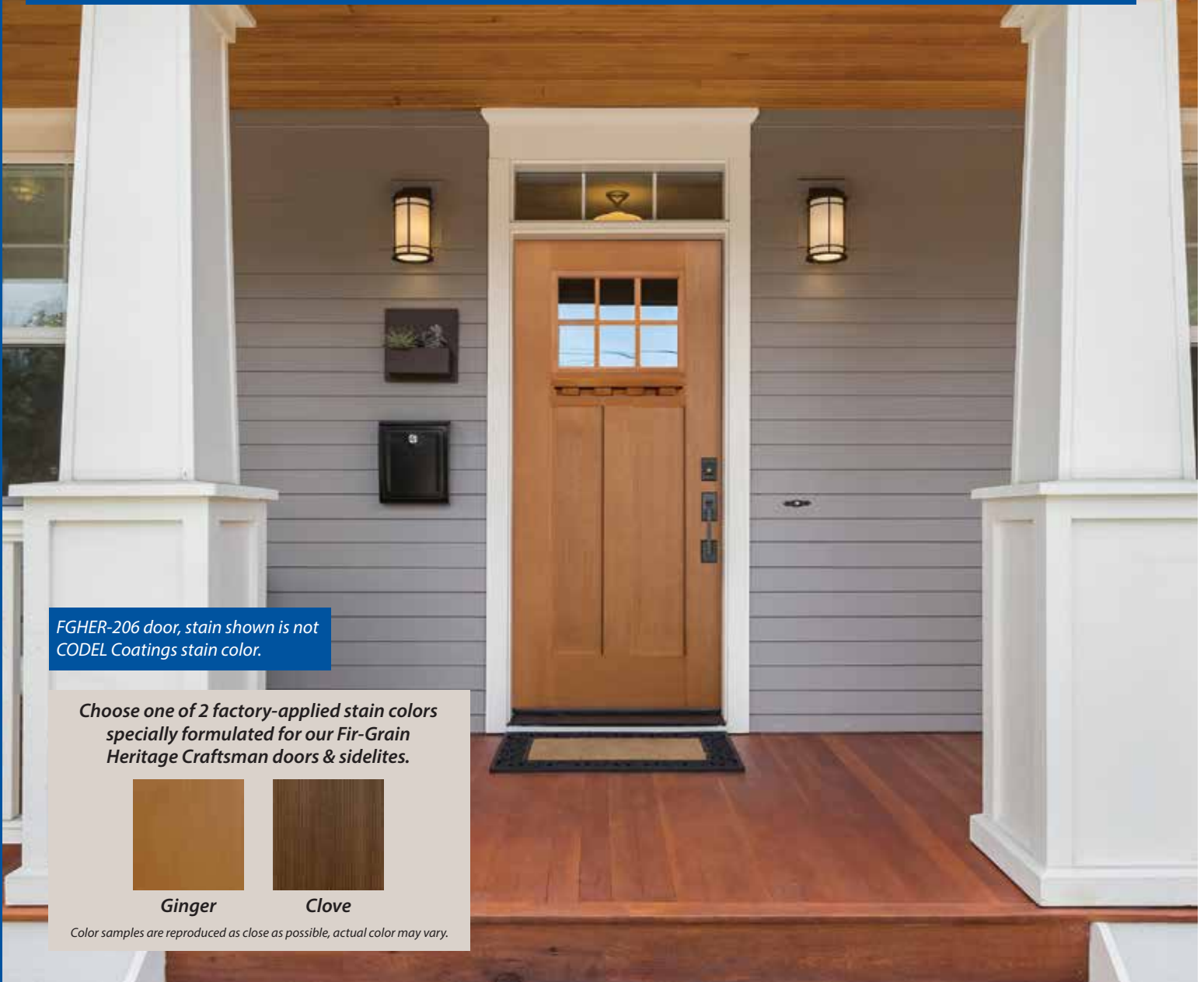

FGHER-206 door, stain shown is not CODEL Coatings stain color.

Choose one of 2 factory-applied stain colors specially formulated for our Fir-Grain Heritage Craftsman doors & sidelites.



Ginger



Clove

Color samples are reproduced as close as possible, actual color may vary.



Clear I.G.

Wood Edge

FG

FGHER-200
(28 210 30)



FG

FGHER-201
(12" & 14")



FG

FGHER-260
(12" & 14")



Clear I.G. w/3-lite SDL*

FG

FGHER-203
(28 210 30)



Wood Edge

FG

FGHER-201
(12" & 14")



FG

FGHER-260
(12" & 14")



Clear I.G. w/4-lite SDL*

FG

FGHER-204
(28 210 30)



Wood Edge

FG

FGHER-202
(12" & 14")



Clear I.G. w/2-lite SDL*

FG

FGHER-260
(12" & 14")

6/8 Fir-Grain Textured Fiberglass Heritage Craftsman



Heritage Lite Kit Frame



Lite kit frame features clean, classic lines, and is reglazeable.

Simulated Divided Lite



Simulated divided lite bars are 5/16" thick x 1-1/8" wide.

C-21F Craftsman Shelf



(Optional)

8/0 Fir-Grain Textured Fiberglass Heritage Craftsman



Choose one of 2 factory-applied stain colors specially formulated for our Fir-Grain Heritage Craftsman doors & sidelites.

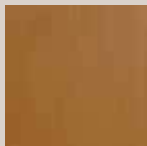

Ginger



Clove

Color samples are reproduced as close as possible, actual color may vary.

FGHER-304 door. Stain color shown is not Codel Coatings.



Clear I.G.

Wood Edge

FG

FGHER-300 (30)



FG

FGHER-301 (12" & 14")



FG

FGHER-280 (12" & 14")



Clear I.G. w/3-Lite SDL*

Wood Edge

FG

FGHER-303 (30)



FG

FGHER-301 (12" & 14")



FG

FGHER-280 (12" & 14")



Clear I.G. w/4-Lite SDL*

Wood Edge

FG

FGHER-304 (30)



FG

FGHER-302 (12" & 14")



FG

FGHER-280 (12" & 14")

8/0 Fir-Grain Textured Fiberglass Heritage Craftsman



Heritage Lite Kit Frame

Lite kit frame features clean, classic lines and is reglazeable.

Simulated Divided Lite

Simulated divided lite bars are 5/16" thick x 1-1/8" wide.

C-21F Craftsman Shelf

(Optional)

CODEL DOORS

**Low-E
Standard**

Smooth Fiberglass Collection



SF8SDL1P doors with Carbon paint.

Key Code Chart

GBG Available w/Grids between Glass

LE Low-E Standard

● Available in 7⁰ Height

▲ Available in 8⁰ Height

■ Extended Leadtime Required

◆ Available w/Panic Blocking/
Closure Reinforcement (6-8 Only)

🔥 20-Min. Fire Rated (*6-8 Only, 3-0 Max Width.)

SFF/SFF20

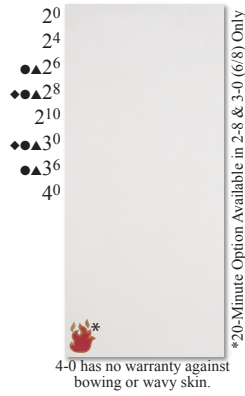

SF6P/SF6P20



SF4P



SF3P



SF3E



SF3PESHK



SF2PSHK



SF3PSHK

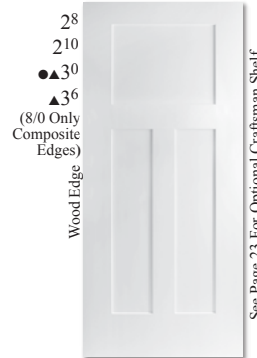

SF5PSHK

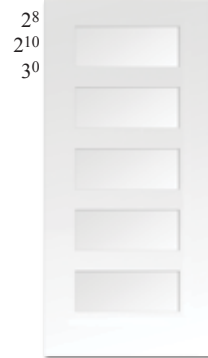

SFW

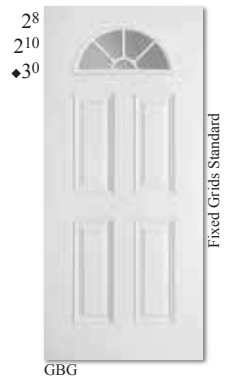

SFC



SF622



Low-E Glass Standard

We Finish What We Start!



Low-E Glass Standard



Color samples are reproduced as close as possible, actual color may vary.

SF81MB2P Raise & Lower Mini Blinds

SF811P

SF4SDL1P Simulated Divided Lite. No Matching Sidelites Available.

SF6SDL1P Simulated Divided Lite. No Matching Sidelites Available.

SF81V1P Vented Glass w/screen

SF81MB1P Raise & Lower Mini Blinds

SF611P

SF291P GBG Only

SF691P Fixed Grids Standard

SF6V1P Vented Glass w/screen

SF61MB1P Raise & Lower Mini Blinds

SF611PC

SF291PC GBG Only

SF691PC Fixed Grids Standard

SF6V1PC Vented Glass w/screen

SF61MB1PC Raise & Lower Mini Blinds

SF611PSHK

SF291PSHK GBG Only

SF691PSHK Fixed Grids Standard

SF6V1PSHK Vented Glass w/screen

SF61MB1PSHK Raise & Lower Mini Blinds

SF1 26, 28, 210, 30, 36

SF20 20, 24, 26, 28, 210, 30, 36

SF9 26, 28, 210, 30, 36

2.0 & 2/4 Glass size is 14x64. 3/6 Glass is 26 x 64 (6-8 & 7-0) 3/6 Glass is 22 x 80 (8-0)

GBG & LE

Low-E Glass Standard



Color samples are reproduced as close as possible, actual color may vary.

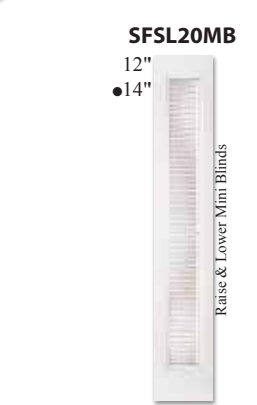
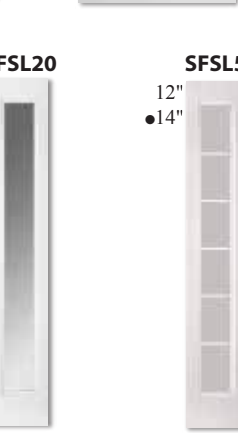
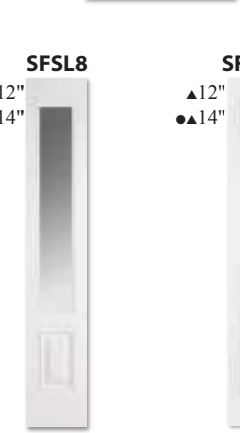
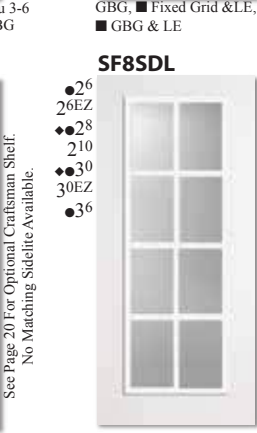
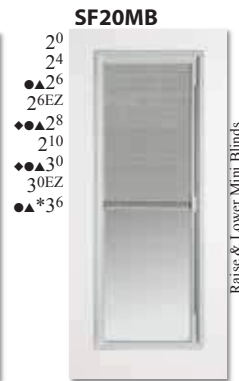
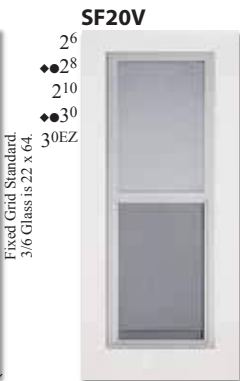
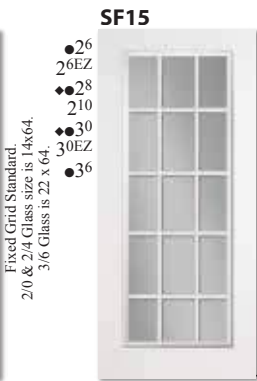
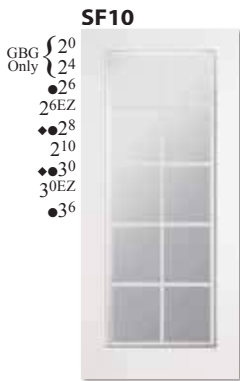

SF6SDL2P door. Paint color shown is not Codel Coatings.



Color samples are reproduced as close as possible, actual color may vary.

CODEL DOORS

Low-E
Standard

Smooth Fiberglass Flush-Glazed Collection (Including GBG & SDL Bars)





SF20FMB Flush-Glazed door with Bright paint.

Key Code Chart

- GBG Available w/ Grids between Glass
- LE Low-E Standard
- Available w/ Extended Leadtime

Flush-Glazed & Flush-Glazed with Grids Between Glass (GBG)

SF61F 6⁸ 2 ⁸ 3 ⁰ 	SF29F 6⁸ 2 ⁸ 3 ⁰ 	SF69F 6⁸ 2 ⁸ 3 ⁰ 	SF61FMB 6⁸ 2 ⁸ 3 ⁰ 
	GBG Only	GBG Only	Raise & Lower MiniBlinds
SF20F 6⁸ 7⁰ 8⁰ 2 ⁰ 2 ⁴ ● 2 ⁶ 2 ⁶ EZ ● 2 ⁸ 2 ¹⁰ ● 3 ⁰ 3 ⁰ EZ ▲ 3 ⁶ 	SF9F 6⁸ & 7⁰ 2 ⁰ ■ 2 ⁴ ● 2 ⁶ 2 ⁶ EZ ■ 2 ⁸ ■ 2 ¹⁰ ● 3 ⁰ 3 ⁰ EZ 	SF10F 6⁸ & 7⁰ 2 ⁰ 2 ⁴ ● 2 ⁶ 2 ⁶ EZ ● 2 ⁸ 2 ¹⁰ ● 3 ⁰ 3 ⁰ EZ 	SF20FMB 6⁸ 7⁰ 8⁰ ● 2 ⁶ ● 2 ⁸ ● 3 ⁰ 
	GBG	GBG	Raise & Lower MiniBlinds
SFSL1F 6⁸ 12" 14" 	SFSL20F 6⁸ 8⁰ 12" 14" 	 <p>Flush-Glazed Profile vs. Standard Lite Kit Profile</p> <p>FG Flush-Glazed Standard</p>	

Grids Between Glass (GBG)

Grids Between Glass (GBG) are flat bars between the glass that are inserted at the time the glass is made, showing the grid but leaving a smooth glass surface for easy cleaning.



Low-E is now our Standard on all Commodity glass. We also offer a high-performance Low-E called Low-E 366. Contact your Codel Rep. for more information.

Low-E

Simulated Divided Lites (SDL)

Simulated Divided Lite (SDL) doors are created by installing SDL bars on the face of the glass in the door. These bars are applied to both sides of the glass to create the look of a true divided lite while maintaining the energy efficiency value of a single lite.



SDL Bar Profile

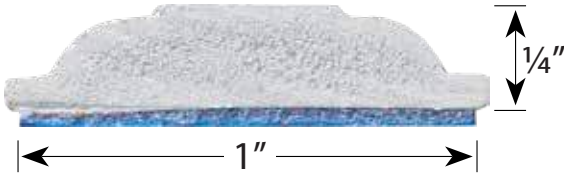

- Available in 6/8, 7/0 & 8/0 Heights
- Extended Leadtime Required
- No Finishing Available on Traditional SDL Doors

6/8, 7/0 & 8/0 Flush-Glazed Simulated Divided Lites (SDL)

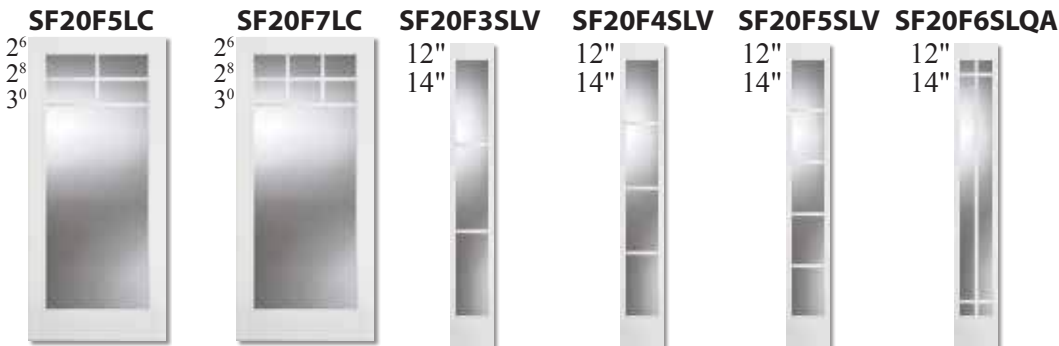

Smooth Fiberglass

Direct Glazed Contemporary Collection

The SF Direct Glazed Collection features glass that is directly glazed into the door to create a seamless blend between the glass and door. The large glass pane allows the most scenery and natural light into your home. This generous portion of glass is available in two models: the 20D with a traditional, Craftsman sticking, in a Smooth or Fir skin (see pages 44-45), and the 20D1P with a modern, Shaker sticking and Brushed Smooth finish.



SF20D1P

Modern, Shaker Sticking and a Brushed Smooth Finish

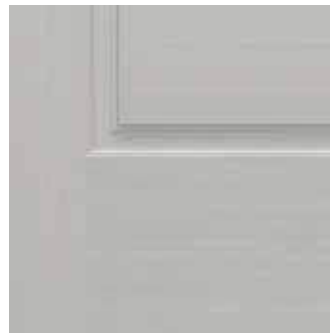

Brushed Smooth Finish



20D1P Sticking

Available in Brushed Smooth Fiberglass Only

SF20D

Traditional, Craftsman Sticking in Smooth Fiberglass

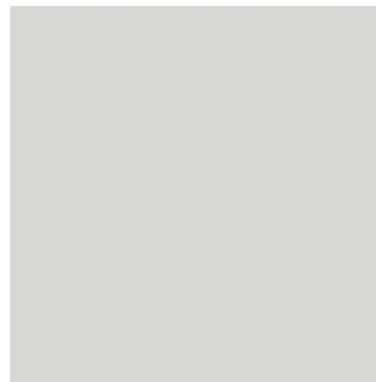
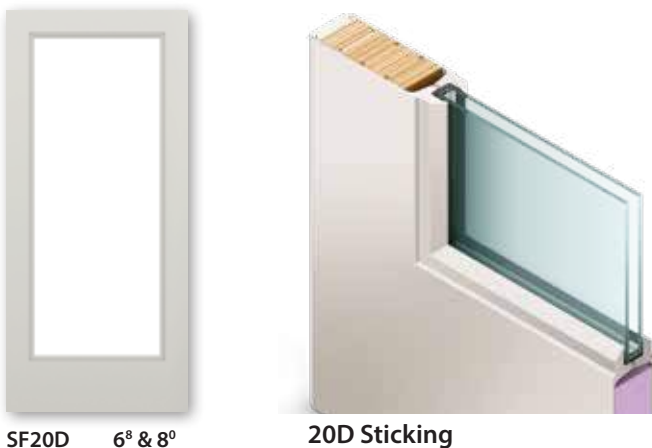

Smooth Finish

Also available in Fir Grain Fiberglass (see pages 44-45)



SF20D1P (x2) door. Paint color shown is not Codel Coatings.

**CODEL
DOORS**

Smooth Fiberglass
**Flush-Glazed
Contemporary
Collection**

Our sleek Aluminum Mullion Bars compliment the clean lines of our flush-glazed smooth fiberglass door. With 5 door styles to choose from, you can create that unique entry you've been looking for. Available in Low-E and Satin Etch.



SF20F3L door and (2) SFSL20F3L3.5 sidelites with Satin Etch glass, finished with Codel Coatings Carbon paint.

NEW
Mullion Bars
Available in 2 Sizes

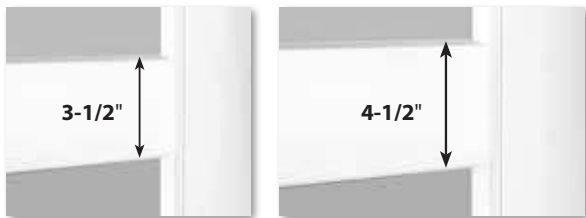

- Flush-Glazed Door Available in 6-8, 7-0, 8-0 & EZ-Fit Heights
- 3-1/2" & 4-1/2" Aluminum Mullion Bars Will Not Shrink
- Matching Sidelites Also Available
- 5/8" OA Glass ONLY

STYLES

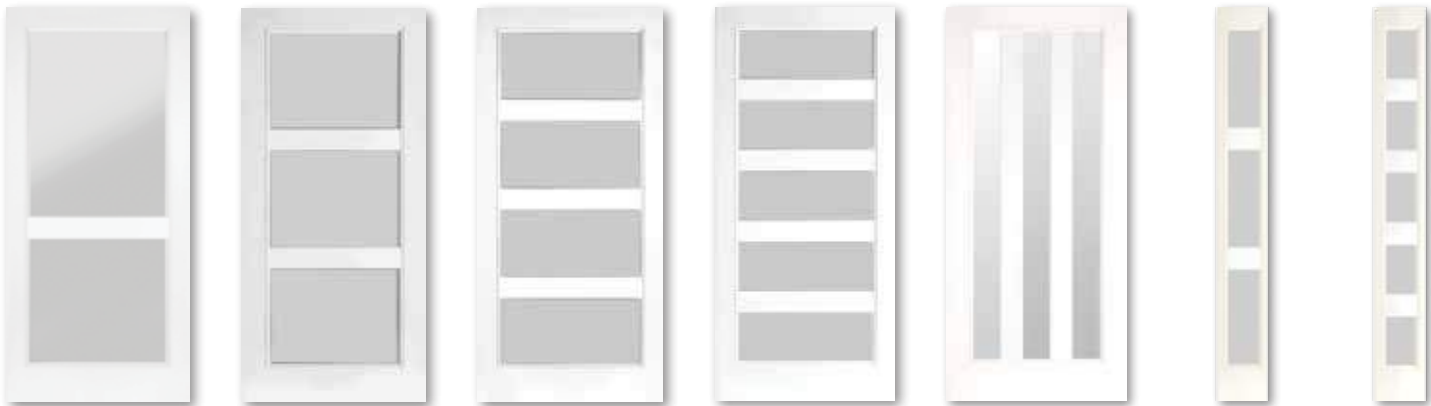

SF20F2L3.5
SF20F2L4.5

SF20F3L3.5
SF20F3L4.5

SF20F4L3.5
SF20F4L4.5

SF20F5L3.5
SF20F5L4.5

SF20F3VL3.5
SF20F3VL4.5

SFSL20F3L3.5
SFSL20F3L4.5

SFSL20F5L3.5
SFSL20F5L4.5



Color samples are reproduced as close as possible, actual color may vary.

CODEL DOORS

Oak Grain Textured Fiberglass Collection

Low-E
Standard



TF6SDL2P door with Cinnamon stain.

Key Code Chart

GBG Available w/Grids Between Glass

LE Low-E Standard

▲ Available in 8⁹ Height

■ Available w/Extended Leadtime.

 20-Min. Fire Rated (6-8 Only)

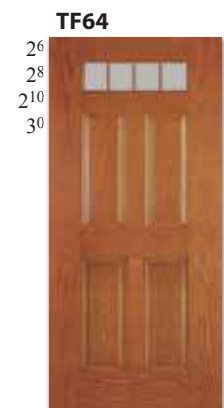
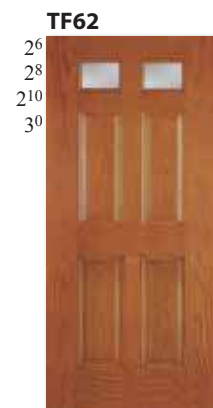

Color samples are reproduced as close as possible, actual color may vary.

OAK GRAIN TEXTURED FIBERGLASS COLLECTION



TF64C



TF64GBG

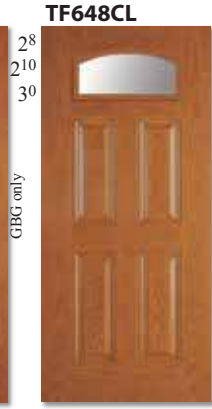

TF648CL

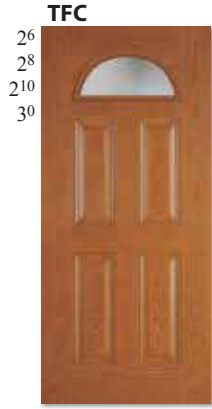

TFC

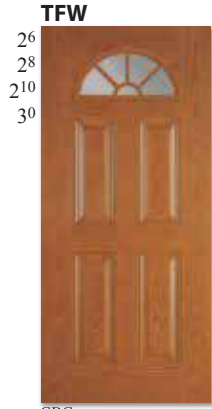

TFW



TF622



TF61



TF29

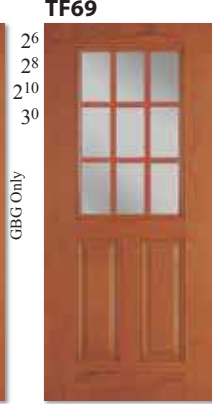

TF69



TF6V

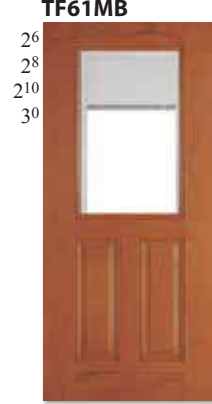

TF61MB



TF1



TF81



TF4SDL2P



TF6SDL2P



TF81MB2P



TF81V2P



TF811P



TF4SDL1P



TF6SDL1P



TF81MB1P



TF81V1P

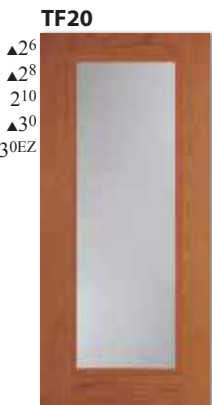

TF20



TF20V



MEDIUM OAK



CEDAR



RED CHERRY



MAHOGANY



WALNUT

Color samples are reproduced as close as possible, actual color may vary.

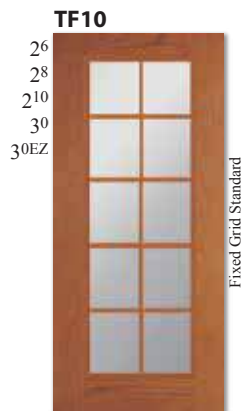

TF10

26
28
210
30
30EZ

Fixed Grid Standard

GBG, GBG & LE
■ Fixed Grid & LE

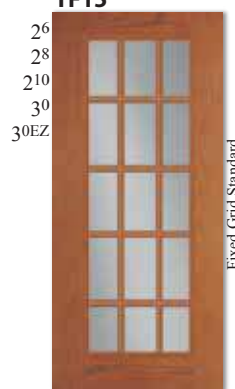

TF15

26
28
210
30
30EZ

Fixed Grid Standard

GBG, ■ Fixed Grid & LE,
■ GBG & LE

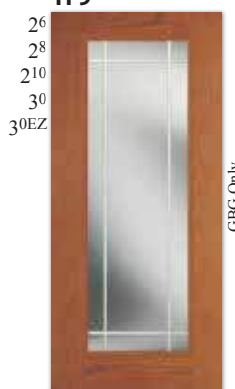

TF9

26
28
210
30
30EZ

GBG Only

■ GBG & LE



TF20MB

▲26
▲28
210
▲30
30EZ

Raise & Lower Mini Blinds

LE 2-8 thru 3-0 ■ LE 2-6 x 6-8
and 2-6, 2-8 & 3-0 x 8-0

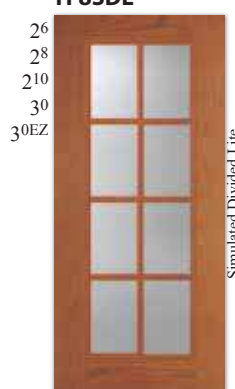

TF8SDL

26
28
210
30
30EZ

Simulated Divided Lite
No Matching Sidelites Available



TF66CL

30

See Page 27 For Optional Craftsman Shelf



TFSDL203

30

Simulated Divided Lite

See Page 27 For Optional Craftsman Shelf
No Matching Sidelites Available



TFSDL206

30

Simulated Divided Lite

See Page 27 For Optional Craftsman Shelf
No Matching Sidelite Available

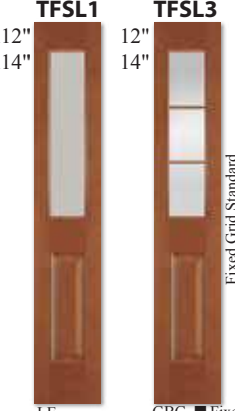

TFSL1

TFSL3

▲12"
▲14"

12"
14"

LE

GBG, ■ Fixed
Grid & LE

Fixed Grid Standard



TFSL8

▲12"
▲14"

■ LE

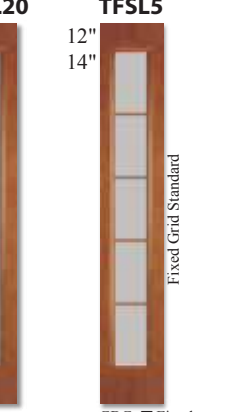

TFSL20

▲12"
▲14"

LE

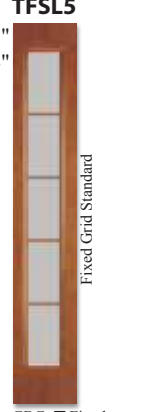

TFSL5

12"
14"

GBG, ■ Fixed
Grid & LE

Fixed Grid Standard



TFSL1MB

TFSL20MB

12"
14"

12"
14"

■ LE

■ LE

Raise & Lower Mini Blinds

Raise & Lower Mini Blinds



TF4P door. Stain color shown is not Codel Coatings.

CODEL DOORS

Low-E
Standard

Oak Grain Textured Fiberglass Flush-Glazed Collection (Including GBG & SDL Bars)



TF20F Flush-Glazed door. Stain color shown is not Codel Coatings.

Key Code Chart

- GBG Available w/Grids Between Glass
- LE Low-E Standard
- ▲ Available in 8⁰ Height
- Available w/Extended Leadtime

Flush-Glazed & Flush-Glazed with Grids Between Glass (GBG)

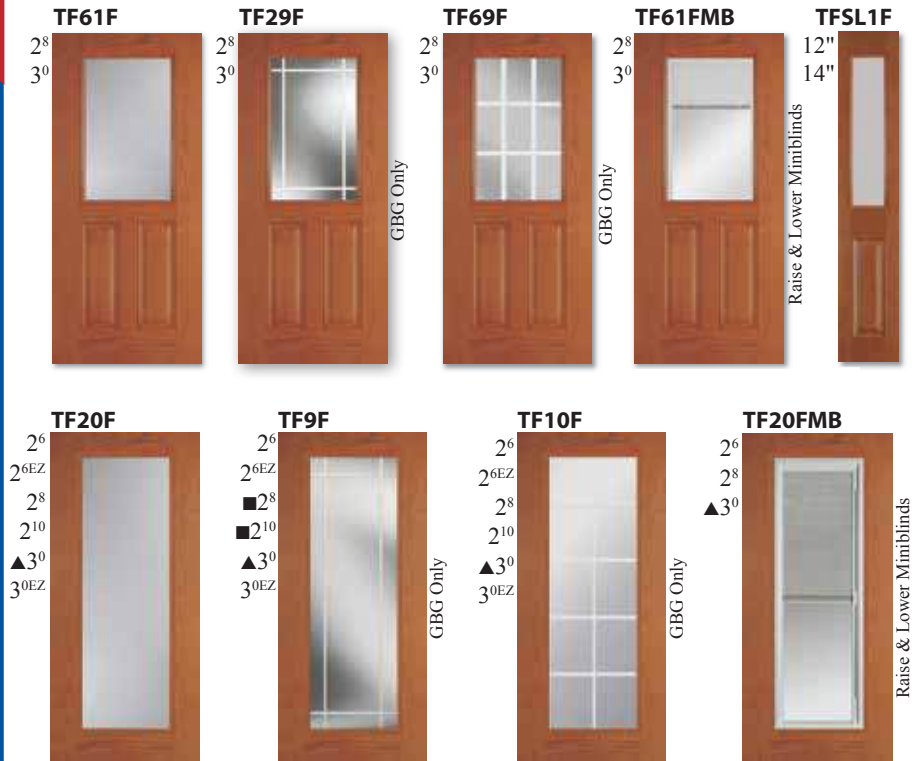

Low-E is now our Standard on all Commodity glass. We also offer a high-performance Low-E called Low-E 366. Contact your Codel Rep. for more information.

Grids Between Glass (GBG)

Grids Between Glass (GBG) are flat bars between the glass that are inserted at the time the glass is made, showing the grid but leaving a smooth glass surface for easy cleaning.



Color samples are reproduced as close as possible, actual color may vary.

Simulated Divided Lites (SDL)

Simulated Divided Lite (SDL) doors are created by installing SDL bars on the face of the glass in the door. These bars are applied to both sides of the glass to create the look of a true divided lite while maintaining the energy efficiency value of a single lite.



SDL Bar Profile

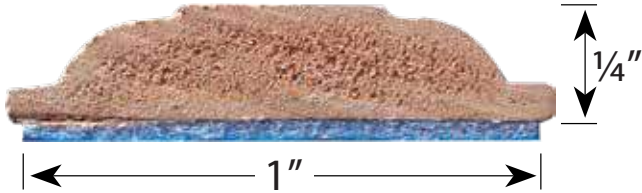

- Available in 6/8 & 8/0 Heights
- Extended Leadtime Required
- No Finishing Available on Traditional SDL Doors

6/8 & 8/0 Flush-Glazed Simulated Divided Lites (SDL)



(Sidelites Not Available in 8/0.)



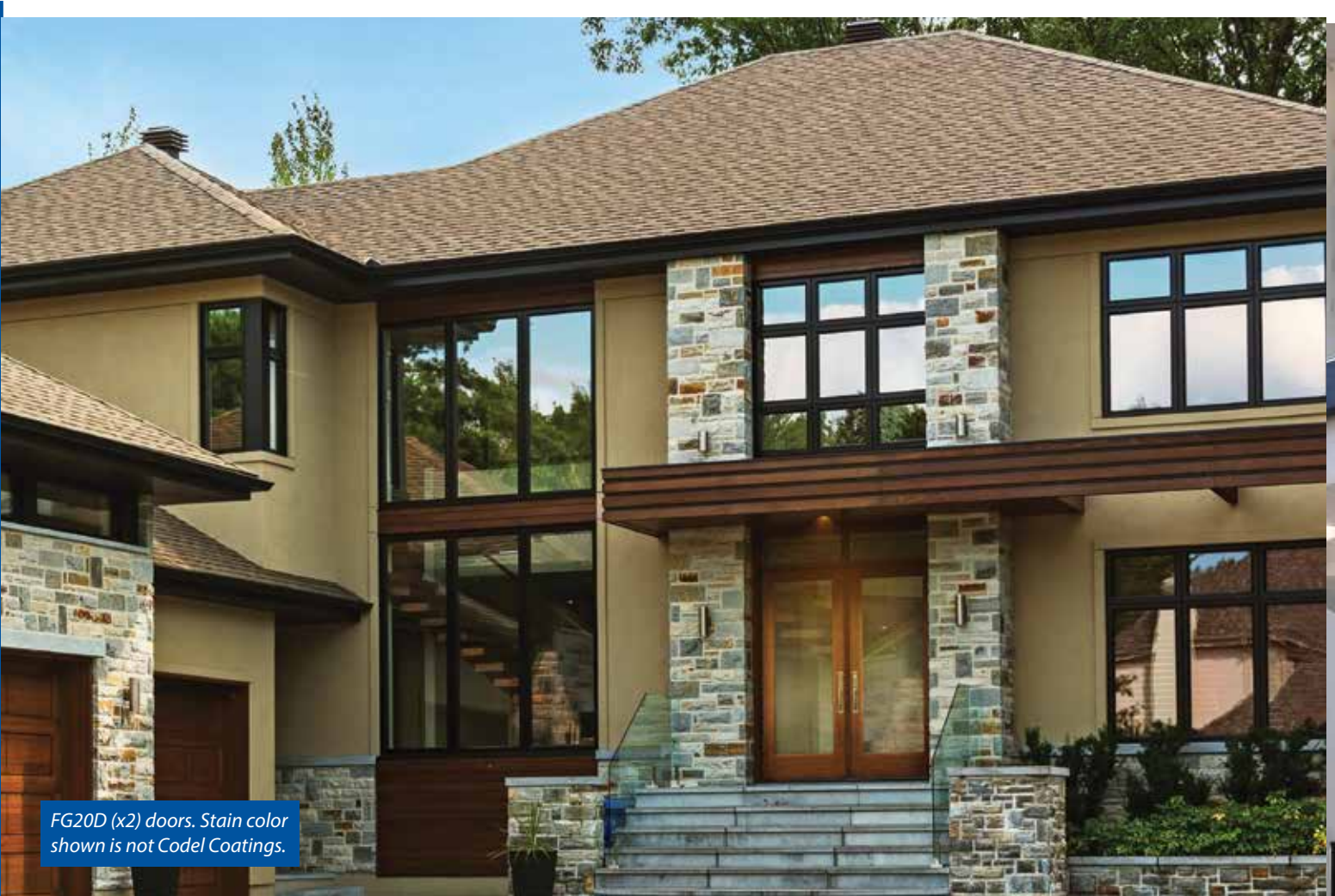

FG20D (x2) doors. Stain color shown is not Codel Coatings.

Fir Grain Fiberglass

Direct Glazed Contemporary

Our Fir Grain Direct Glazed Contemporary FG20D features glass that is directly glazed into the door to create a seamless blend between the glass and door. The large glass pane allows the most scenery and natural light into your home. The FG20D has a traditional Craftsman sticking.

**Also available in Smooth Fiberglass!
(see pages 36-37)**



20D Sticking



FG20D 6⁸ & 8⁰



FG20D (x2) doors. Stain color shown is not Codel Coatings.

CODEL DOORS

Fir Grain Textured Fiberglass Collection



FG1PSHK door. Stain color shown is not Codel Coatings.

Key Code Chart

GBG Available w/Grids Between Glass

LE Available w/Low-E Glass

● Available in 7⁰ Height

▲ Available in 8⁰ Height

■ Available w/Extended Leadtime

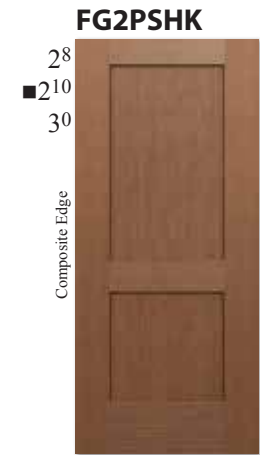

See Page 47 For Optional Glass.
No Matching Sidelites Available.



See Pages 48-49 For Optional Glass.
No Matching Sidelites Available.



See Page 27 For Optional Craftsman Shelf,
Optional Glass and Sidelite Options.



See Pages 50-51 For Optional Glass.
No Matching Sidelites Available.



Choose one of 2 factory-applied stain colors specially formulated for our Fir Grain Textured Fiberglass doors & sidelites. (Optional)



Ginger

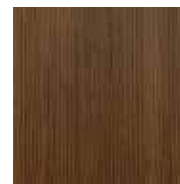

Clove

Color samples are reproduced as close as possible, actual color may vary.

2-Panel Premium Shaker Fiberglass Door Collection

(Available in Smooth Fiberglass and Fir Grain Fiberglass)

2-Panel Premium Shakers

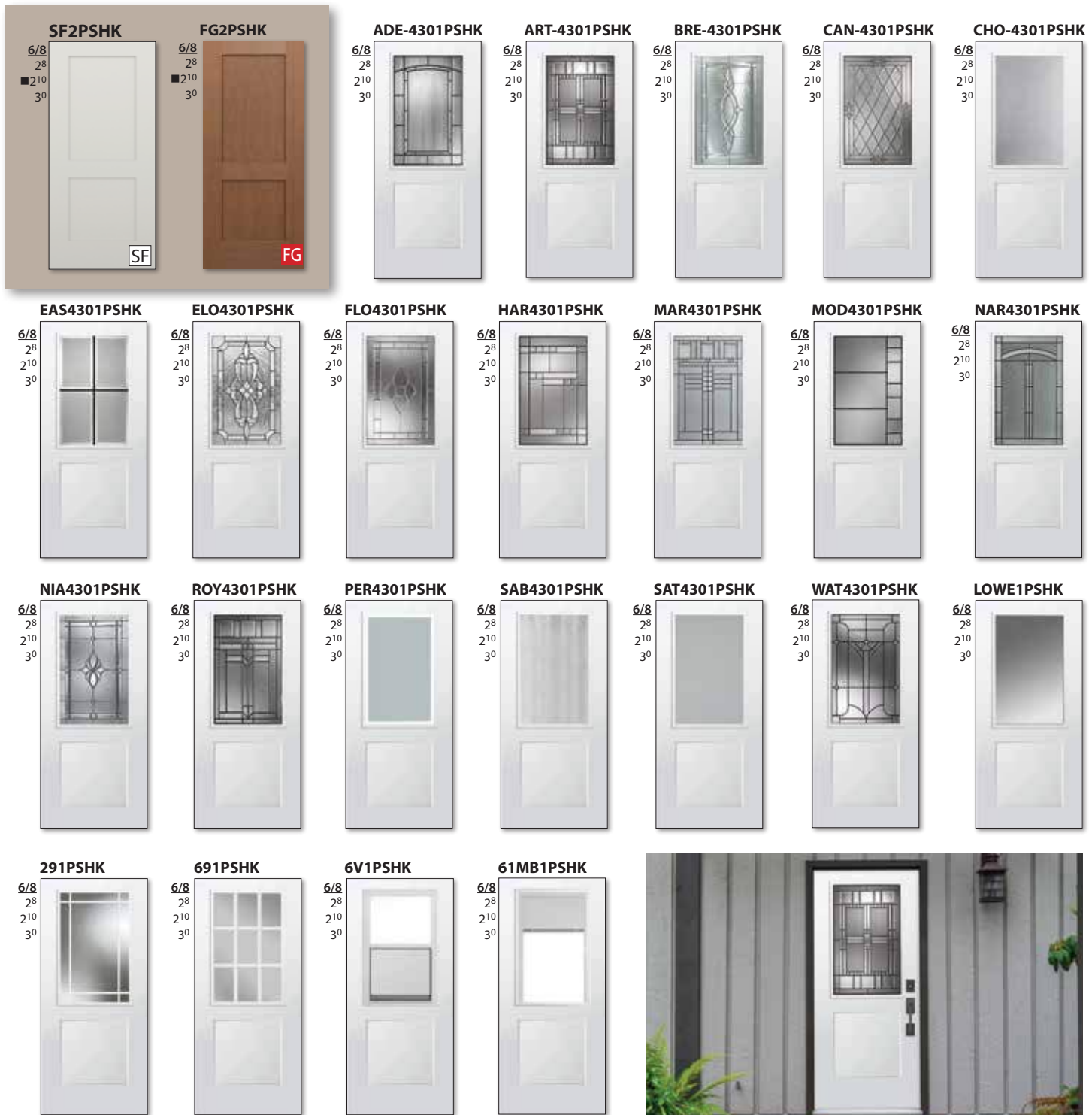

SF Smooth Fiberglass FG Fir Grain Textured

ART-4301PSHK door with Codel Coatings Bright paint.

Optional Fir Stain and Paint Colors



Color samples are reproduced as close as possible, actual color may vary. See back cover for larger swatches.

One Door Style, Four Options

(Available in Smooth Fiberglass and Fir Grain Fiberglass)

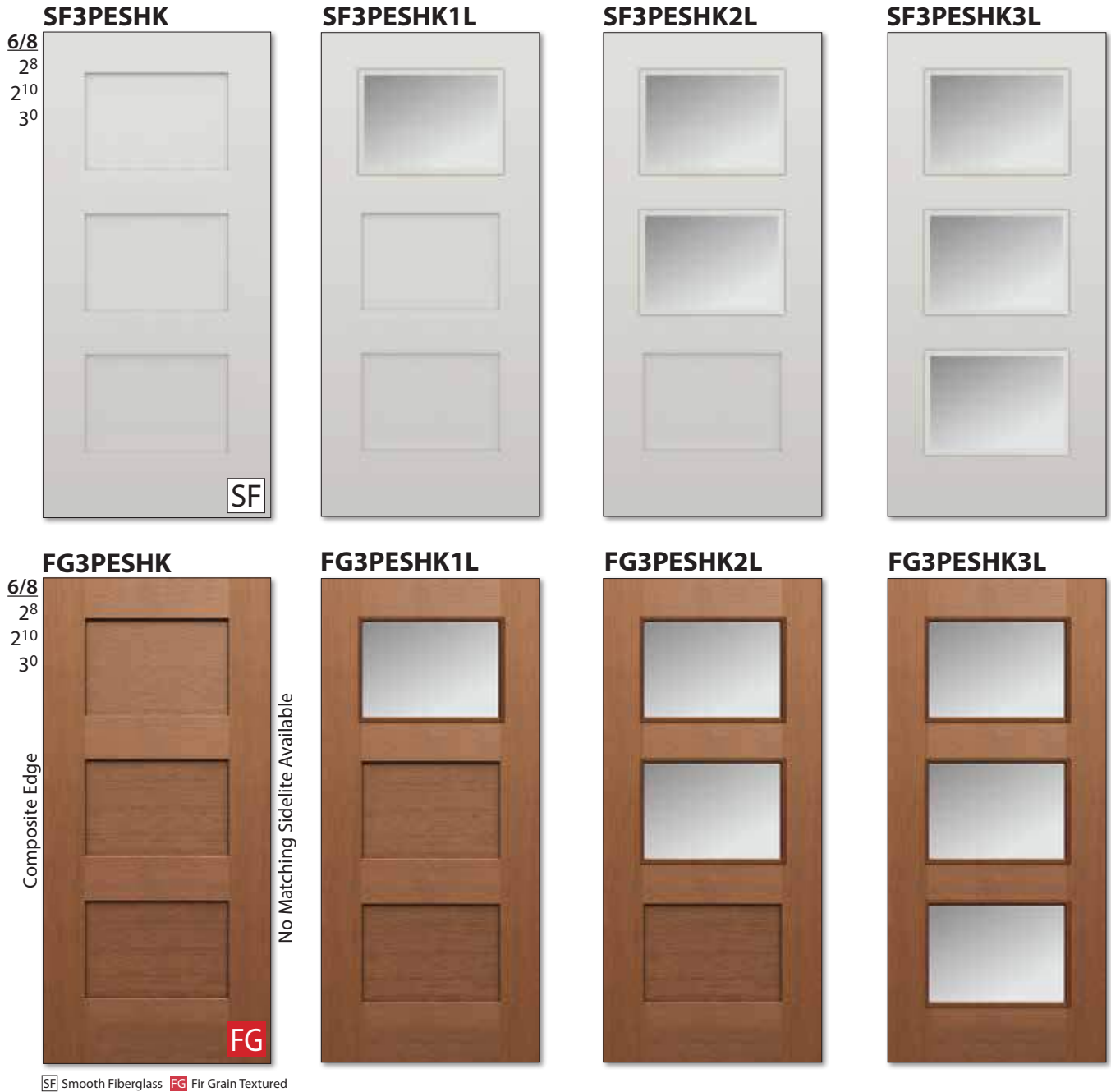

Optional Fir Stain and Paint Colors

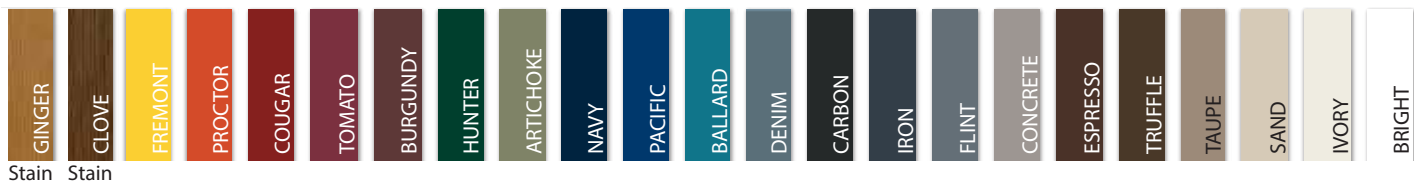

Color samples are reproduced as close as possible, actual color may vary. See back cover for larger swatches.

Glass Options (Glass size: 22" x 15-1/4")



Low-E



Sable



Satin Etch



Chord



Adelaide

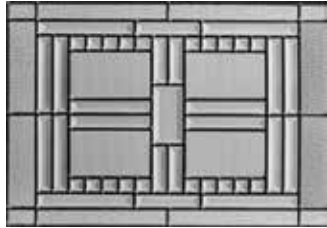

Artisan



Harlow

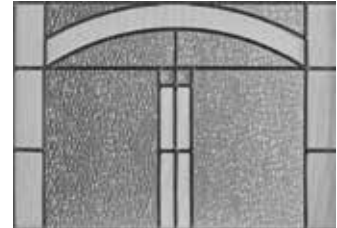

Narrows

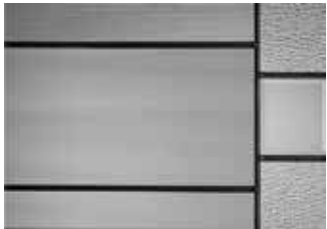

Modena

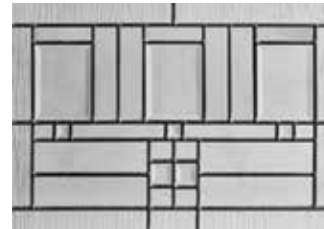

Maren



SF3PSHK2LMAR door. Paint color shown is not Codel Coatings.

One Door Style, Six Options

(Available in Smooth Fiberglass and Fir Grain Fiberglass)



Smooth Fiberglass Fir Grain Textured

Glass Options (Glass size: 22" x 8")



Low-E



Sable



Satin Etch



Chord

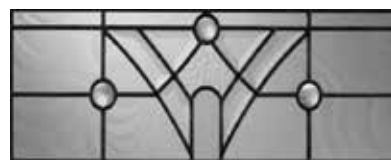

Waterton

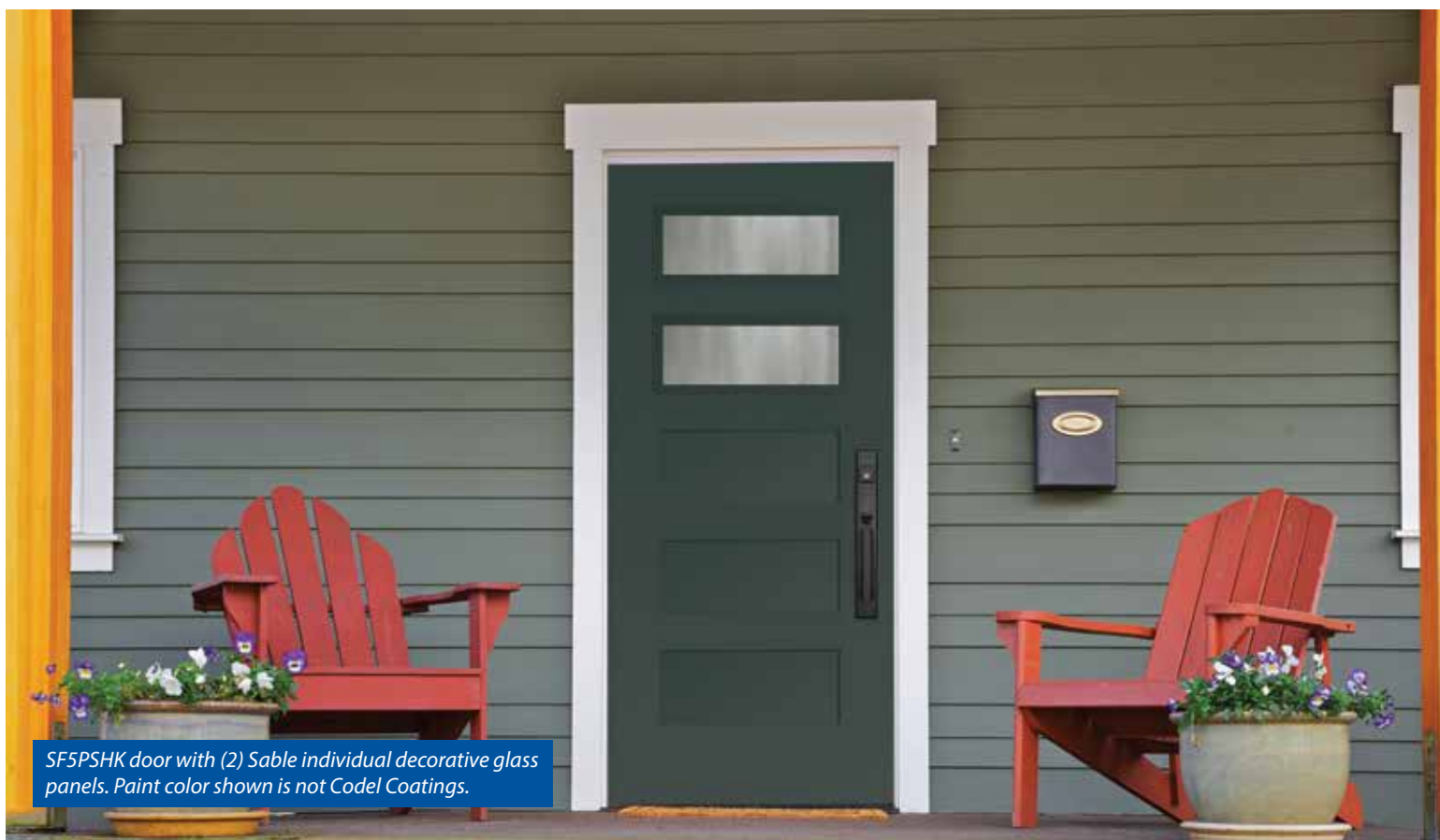

SF5PSHK door with (2) Sable individual decorative glass panels. Paint color shown is not Codel Coatings.



FG5PSHK4LWAT door. Stain color shown is not Codel Coatings.



Top panel shows glass insert with Contemporary Low Profile Lite Kit frame.

Optional Fir Stain and Paint Colors

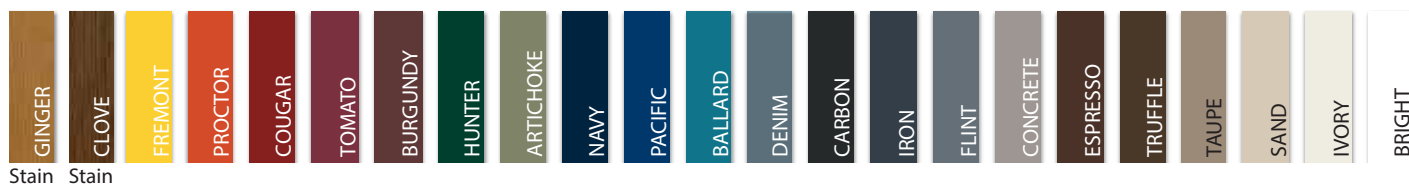

Stain Stain

Color samples are reproduced as close as possible, actual color may vary. See back cover for larger swatches.



Rustic CAN-430W door. Stain color shown is not Codel Coatings.

6/8 Rustic Fiberglass Collection "Rustic Hardwood" Grain



RUS1PV (30)

TF



RUS2PV (30)

TF



RUS2PF (30)

TF



Standard Lite Kit Frame (Not Wrought Iron)

RUSL20 (12" & 14")

TF



Chateau - Wrought Iron Frame, Wrought Iron Grille

CHA-439W (30)

TF



Chateau - Wrought Iron Frame, Wrought Iron Grille

CHA-160W (12" & 14")

TF



"Knotty Alder" Grain

RUS2PAKA (30)

KA



"Knotty Alder" Grain

RUS2PAKASL (14")

KA

TF Textured Fiberglass KA Knotty Alder

6/8 Rustic Collection

8/0 Rustic Collection



Decorative Options for Rustic Doors

Clavos, hinge straps and speakeasies add an authentic touch to your Rustic door.

Clavos

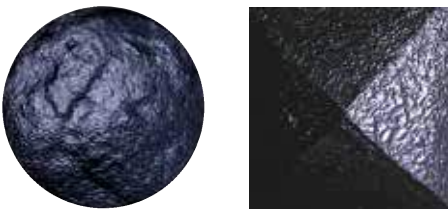

Codel offers clavos in 1-1/2" round or 1-1/2" square decorative black metal. Clavos and hinge straps are shipped loose so the customer can apply them on site in the design of their choice. (Clavos and hinge straps come installed on prefinished doors only.)

Straps & Clavos



1-1/2" Clavos and 18" hinge straps can be added to Rustic doors.

Essex Speakeasy

A Speakeasy adds a touch of old-world charm. Sea Spray glass door can open; when closed, Speakeasy seals tightly to prevent air infiltration. (Size: 10" wide x 12" high.)



(Exterior View)

(Interior View)



Lite Kit Frame

The galvanized frame is coated prior to powder coating for additional weather protection. It features a distinctive iron grille that enhances the old-world styling of our Rustic Door Collection.

CODEL
DOORS

CODEL DOORS

Low-E
Standard

Steel Door Collection (6/8 ONLY)



Steel C69 door with Bright paint.

Key Code Chart

GBG Available w/Grids between Glass

LE Available w/Low-E Glass

■ Extended Leadtime Required

🔥 20-Min. Fire Rated (*6-8 Only, 3-0 Max Width.)



STEEL DOORS

The wood-edge steel door series is a popular choice for new construction as well as remodeling projects.

The versatility and thermal advantages of a wood-edge door are combined with the durability of 24-gauge steel facings. Units are permanently held in place by the adhesion of the polyurethane core.

After assembly, doors are primed for superior corrosion resistance. Wood-edge steel doors are available with a *20-minute fire rating for all 6'8" doors up to 3'0" wide. (*Excludes doors w/lite kits.)

Thermal Performance values established in accordance with the International Energy Conservation Code (IECC) section 102.3

	R value	U value	SHGC value
Steel door unit without Glass	6.25	0.16	0.00
Steel door unit with 1/2 LowE Glass	4.55	0.22	0.16
Steel door unit with Full LowE Glass	3.57	0.28	0.28
Steel door unit with 1/4 Decorative Glass	5.55	0.18	0.07
Steel door unit with 1/2 Decorative Glass	4.16	0.24	0.15
Steel door unit with 3/4 Decorative Glass	4.17	0.24	0.20
Steel door unit with Full Decorative Glass	3.45	0.29	0.27

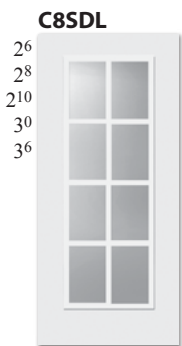
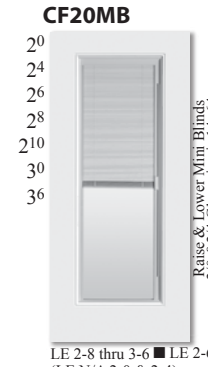
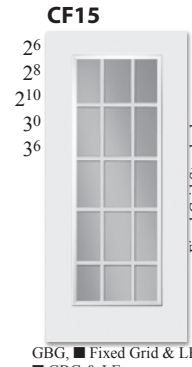
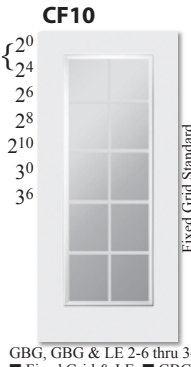
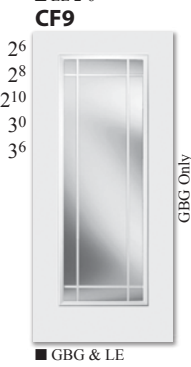
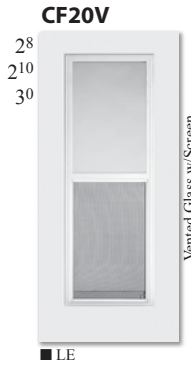
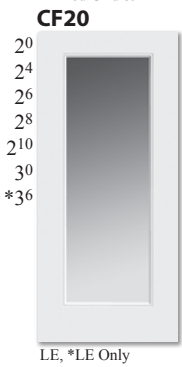
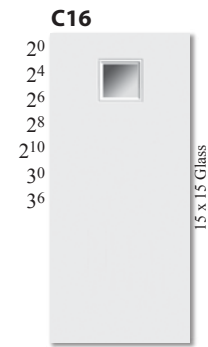
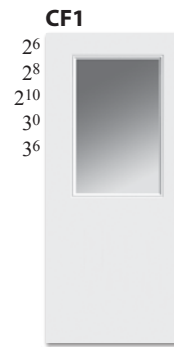
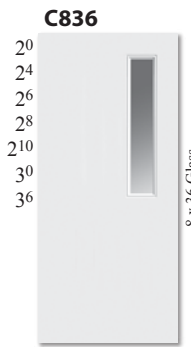
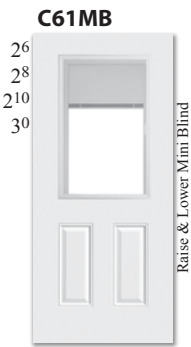
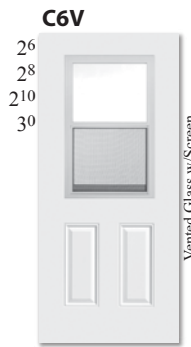
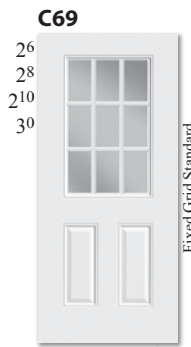
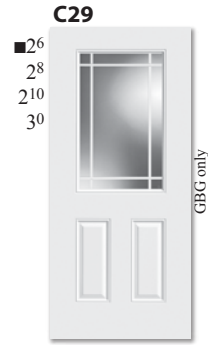
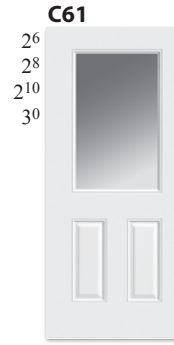
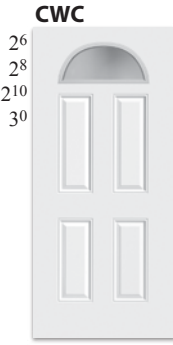
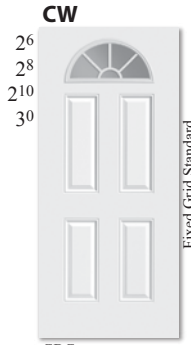
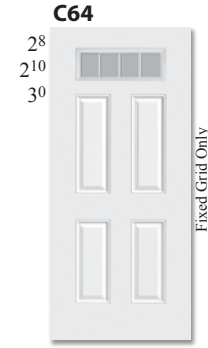
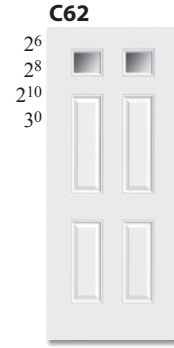
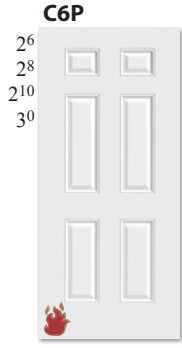
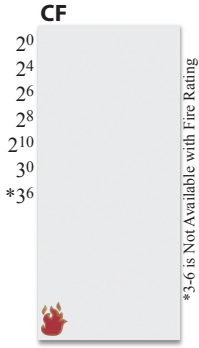

FAST-FRAME™

Introducing the Ultimate in Adjustable Steel Door Frames

FAST-FRAME'S advanced design adds a new dimension of flexibility and durability to Codel's steel entry door line. FAST-FRAME™ features closure kits with full 1" of adjustability to accommodate almost any variation in wall construction. This easy-to-install, user-friendly, kerfed steel door frame system is applicable to a full range of residential and commercial applications - wood or steel stud construction. FAST FRAME is engineered to meet the most stringent code requirements, including structural, impact and 90-minute fire ratings.



C690 door with Bright paint.

Adjustable T-Strike
1/4" of adjustment allows for ease of field installations for proper door closure

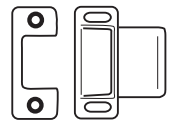

Closure Span Adjustment Chart

Wall Sizes
4 1/2" - 5 1/2"
5 1/2" - 6 1/2"
6 1/2" - 7 1/2"
7 1/2" - 8 1/2"
8 1/2" - 9 1/2"
9 1/2" - 10 1/2"

Weatherstripping
Schlegel foam-filled compression (QEBD500)
90 Min. Fire Rating

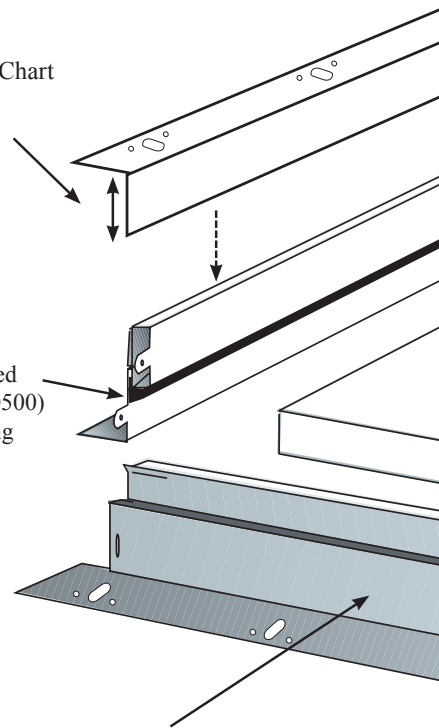

Prime Bright White EG Galvanized 20-gauge steel to provide superior corrosion resistance and an optimal surface for painting

APPLICATIONS

- Multi-Family ● Assisted Living ● Motel/Hotel ● House to Garage ● Garage to Exterior



FIRE LABELS

90 Minute Fire Rating - up to 3'0" x 6'8".

CLOSURE TEST In a 90-minute application, the door will close and latch from 18" if the following Fast-Frame components are used:

- QEBD500 Foam-Filled Compression Weatherstripping
- Factory Sweep ● Adjustable T-Strike ● Factory Supplied Sills



STRUCTURAL PERFORMANCE AND IMPACT RATING

Design pressure ratings are available for compliance with national, state and local wind load and/or missile requirements. Product approval under the Miami-Dade BCCO NOA or Intertek Testing Services/Warnock Hersey® programs.

Door Handing

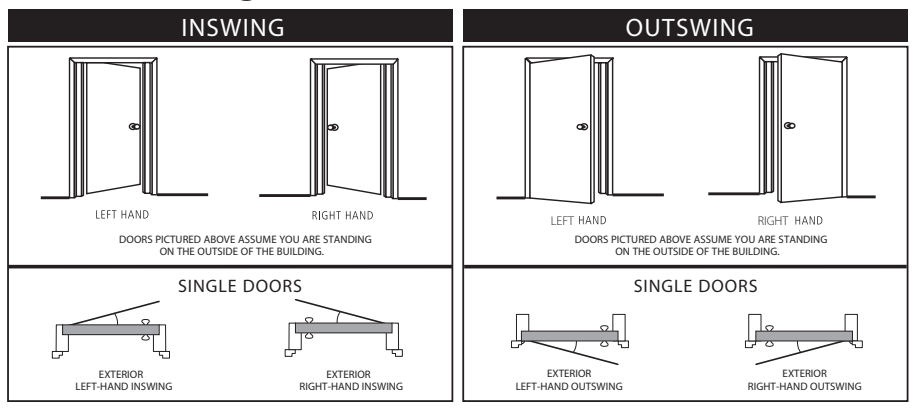

SILLS
 Standard Inswing
 Thermally broken - 5 5/8" width
 Optional extenders for larger wall sizes
 Note: Not for use on outswing applications.



Handicap (ADA)
 Double Slope 4-9/16" & 6-9/16" width



Tile Face 4-1/4" and 6-1/4"

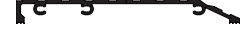

■ *Extended Lead Time

Outer Adjustable Closure
 20-gauge Steel
 2 uprights - 1 header

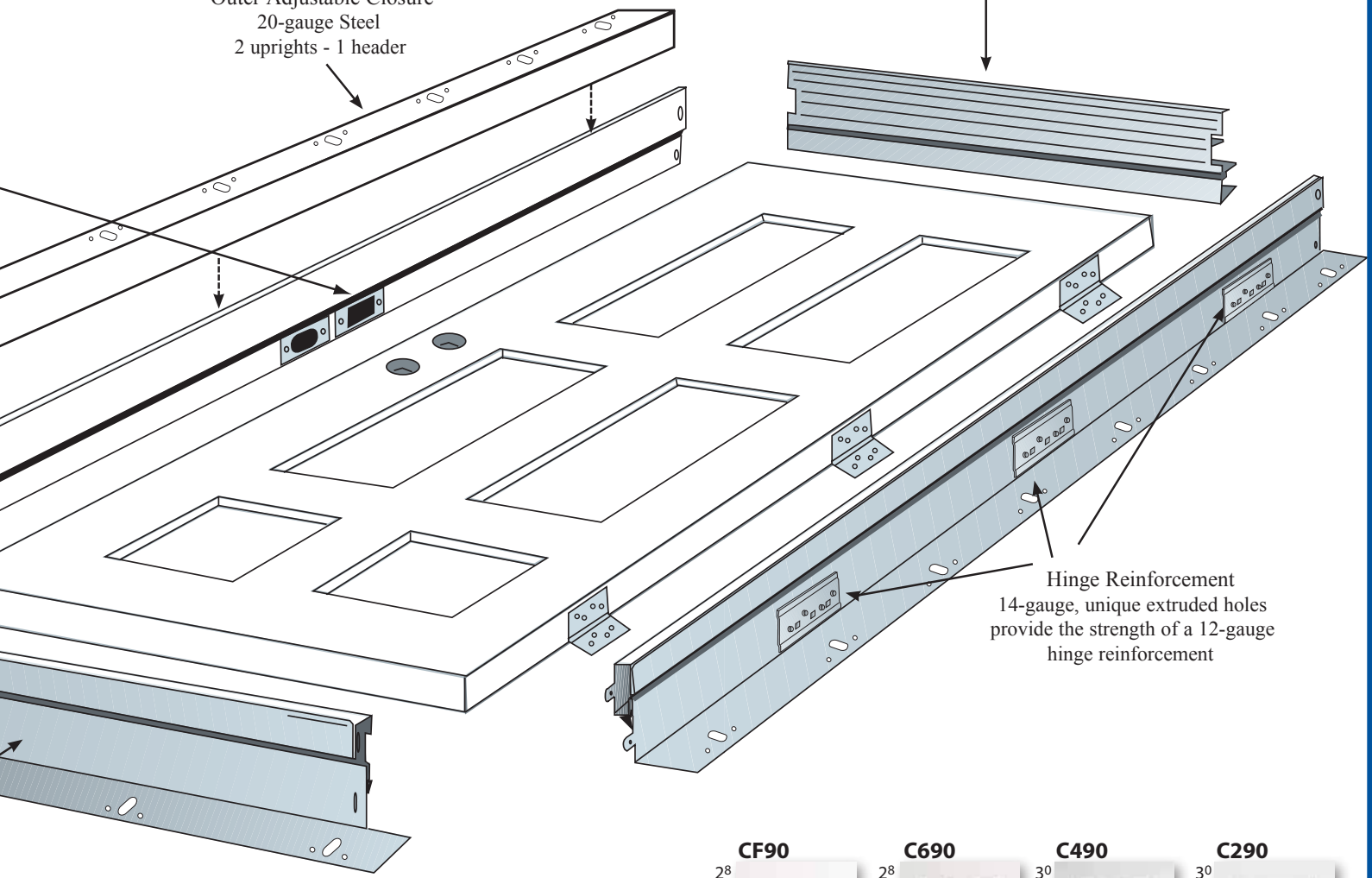

Hinge Reinforcement
 14-gauge, unique extruded holes provide the strength of a 12-gauge hinge reinforcement

Prehung Door Sizes

Nominal Door Size	Rough Opening Size (wood stud)	
	Width x Height	Width x Height
Single Door 2' 8" x 6' 8"	33-1/4" x 81-3/8"	
3' 0" x 6' 8"	37-1/4" x 81-3/8"	
3' 0" x 7' 0"	37-1/4" x 85-3/8"	

-All dimensions shown are for doors with standard inswing sill.
 Deduct 13/16" for bumper outswing or handicap compliant sill.



■ **Extended Leadtime Required.** **90-Minute Fire-Rated.**

*Available in 7/0



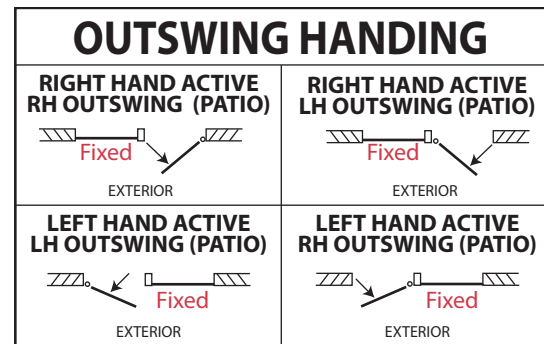
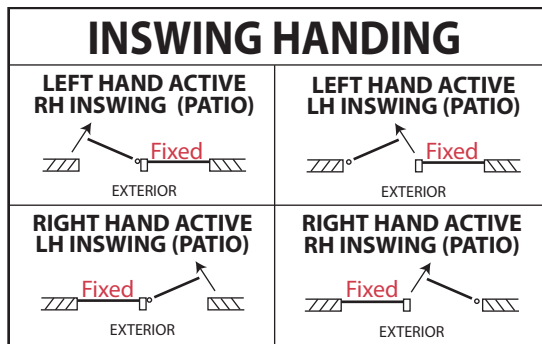

SINGLE-HINGED INSWING FIBERGLASS PATIO DOOR

The Single-Hinged Inswing Patio door provides the look of a double door, with the functionality of a single door. The “one-door-fixed/one-door-operable” configuration comes standard with a sliding screen, and is perfect for areas where interior space is limited. Available in a variety of sizes ranging from standard to retro-fit (EZ-Fit), the Single-Hinged Inswing Patio door is a great choice for new construction and remodel projects, alike.

(Outswing option also available with no sliding screen)



*Screen not available on outswings.

	Standard 6-8 Patio Sizes (SP)	EZ-Fit (Retro) Patio Sizes (EZP)																																
<p>20F/20</p>  <p>Low-E Only</p> <p>SF TF</p>	<table border="1"> <thead> <tr> <th>FLUSH-GLAZED SIZES</th> <th>LITE KIT SIZES</th> </tr> </thead> <tbody> <tr> <td>SF20FSP 5-0 x 6-8 5-4 x 6-8 5-8 x 6-8 6-0 x 6-8</td> <td>SF20SP 5-0 x 6-8 5-4 x 6-8 5-8 x 6-8 6-0 x 6-8</td> </tr> <tr> <td>TF20FSP 5-0 x 6-8 5-4 x 6-8 5-8 x 6-8 6-0 x 6-8</td> <td>TF20SP 5-0 x 6-8 5-4 x 6-8 5-8 x 6-8 6-0 x 6-8</td> </tr> </tbody> </table>	FLUSH-GLAZED SIZES	LITE KIT SIZES	SF20FSP 5-0 x 6-8 5-4 x 6-8 5-8 x 6-8 6-0 x 6-8	SF20SP 5-0 x 6-8 5-4 x 6-8 5-8 x 6-8 6-0 x 6-8	TF20FSP 5-0 x 6-8 5-4 x 6-8 5-8 x 6-8 6-0 x 6-8	TF20SP 5-0 x 6-8 5-4 x 6-8 5-8 x 6-8 6-0 x 6-8	<table border="1"> <thead> <tr> <th>FLUSH-GLAZED SIZES</th> <th>LITE KIT SIZES</th> </tr> </thead> <tbody> <tr> <td>SF20FEZP 5-0 x EZ 6-0 x EZ</td> <td>SF20EZP 5-0 x EZ 6-0 x EZ</td> </tr> <tr> <td>TF20FEZP 5-0 x EZ 6-0 x EZ</td> <td>TF20EZP 6-0 x EZ</td> </tr> </tbody> </table>	FLUSH-GLAZED SIZES	LITE KIT SIZES	SF20FEZP 5-0 x EZ 6-0 x EZ	SF20EZP 5-0 x EZ 6-0 x EZ	TF20FEZP 5-0 x EZ 6-0 x EZ	TF20EZP 6-0 x EZ																				
FLUSH-GLAZED SIZES	LITE KIT SIZES																																	
SF20FSP 5-0 x 6-8 5-4 x 6-8 5-8 x 6-8 6-0 x 6-8	SF20SP 5-0 x 6-8 5-4 x 6-8 5-8 x 6-8 6-0 x 6-8																																	
TF20FSP 5-0 x 6-8 5-4 x 6-8 5-8 x 6-8 6-0 x 6-8	TF20SP 5-0 x 6-8 5-4 x 6-8 5-8 x 6-8 6-0 x 6-8																																	
FLUSH-GLAZED SIZES	LITE KIT SIZES																																	
SF20FEZP 5-0 x EZ 6-0 x EZ	SF20EZP 5-0 x EZ 6-0 x EZ																																	
TF20FEZP 5-0 x EZ 6-0 x EZ	TF20EZP 6-0 x EZ																																	
<p>10F/10</p>  <p>10-Lite Fixed or GBG</p> <p>SF TF</p>	<table border="1"> <thead> <tr> <th>FLUSH-GLAZED SIZES</th> <th>LITE KIT SIZES</th> </tr> </thead> <tbody> <tr> <td>SF10FSP 5-0 x 6-8 5-4 x 6-8 5-8 x 6-8 6-0 x 6-8</td> <td>SF10SP 5-0 x 6-8 5-4 x 6-8 5-8 x 6-8 6-0 x 6-8</td> </tr> <tr> <td>TF10FSP 5-0 x 6-8 5-4 x 6-8 5-8 x 6-8 6-0 x 6-8</td> <td>TF10SP 5-0 x 6-8 5-4 x 6-8 5-8 x 6-8 6-0 x 6-8</td> </tr> </tbody> </table>	FLUSH-GLAZED SIZES	LITE KIT SIZES	SF10FSP 5-0 x 6-8 5-4 x 6-8 5-8 x 6-8 6-0 x 6-8	SF10SP 5-0 x 6-8 5-4 x 6-8 5-8 x 6-8 6-0 x 6-8	TF10FSP 5-0 x 6-8 5-4 x 6-8 5-8 x 6-8 6-0 x 6-8	TF10SP 5-0 x 6-8 5-4 x 6-8 5-8 x 6-8 6-0 x 6-8	<table border="1"> <thead> <tr> <th>FLUSH-GLAZED SIZES</th> <th>LITE KIT SIZES</th> </tr> </thead> <tbody> <tr> <td>SF10FEZP 5-0 x EZ 6-0 x EZ</td> <td>SF10EZP 5-0 x EZ 6-0 x EZ</td> </tr> <tr> <td>TF10FEZP 5-0 x EZ 6-0 x EZ</td> <td>TF10EZP 6-0 x EZ</td> </tr> </tbody> </table>	FLUSH-GLAZED SIZES	LITE KIT SIZES	SF10FEZP 5-0 x EZ 6-0 x EZ	SF10EZP 5-0 x EZ 6-0 x EZ	TF10FEZP 5-0 x EZ 6-0 x EZ	TF10EZP 6-0 x EZ																				
FLUSH-GLAZED SIZES	LITE KIT SIZES																																	
SF10FSP 5-0 x 6-8 5-4 x 6-8 5-8 x 6-8 6-0 x 6-8	SF10SP 5-0 x 6-8 5-4 x 6-8 5-8 x 6-8 6-0 x 6-8																																	
TF10FSP 5-0 x 6-8 5-4 x 6-8 5-8 x 6-8 6-0 x 6-8	TF10SP 5-0 x 6-8 5-4 x 6-8 5-8 x 6-8 6-0 x 6-8																																	
FLUSH-GLAZED SIZES	LITE KIT SIZES																																	
SF10FEZP 5-0 x EZ 6-0 x EZ	SF10EZP 5-0 x EZ 6-0 x EZ																																	
TF10FEZP 5-0 x EZ 6-0 x EZ	TF10EZP 6-0 x EZ																																	
<p>9F/9</p>  <p>9-Lite Marginal, GBG Only</p> <p>SF TF</p>	<table border="1"> <thead> <tr> <th>FLUSH-GLAZED SIZES</th> <th>LITE KIT SIZES</th> </tr> </thead> <tbody> <tr> <td>SF9FSP 5-0 x 6-8 5-4 x 6-8 5-8 x 6-8 6-0 x 6-8</td> <td>SF9SP 5-0 x 6-8 5-4 x 6-8 5-8 x 6-8 6-0 x 6-8</td> </tr> <tr> <td>TF9FSP 5-0 x 6-8 5-4 x 6-8 5-8 x 6-8 6-0 x 6-8</td> <td>TF9SP 5-0 x 6-8 5-4 x 6-8 5-8 x 6-8 6-0 x 6-8</td> </tr> </tbody> </table>	FLUSH-GLAZED SIZES	LITE KIT SIZES	SF9FSP 5-0 x 6-8 5-4 x 6-8 5-8 x 6-8 6-0 x 6-8	SF9SP 5-0 x 6-8 5-4 x 6-8 5-8 x 6-8 6-0 x 6-8	TF9FSP 5-0 x 6-8 5-4 x 6-8 5-8 x 6-8 6-0 x 6-8	TF9SP 5-0 x 6-8 5-4 x 6-8 5-8 x 6-8 6-0 x 6-8	<table border="1"> <thead> <tr> <th>FLUSH-GLAZED SIZES</th> <th>LITE KIT SIZES</th> </tr> </thead> <tbody> <tr> <td>SF9FEZP 5-0 x EZ 6-0 x EZ</td> <td>SF9EZP 5-0 x EZ 6-0 x EZ</td> </tr> <tr> <td>TF9FEZP 5-0 x EZ 6-0 x EZ</td> <td>TF9EZP 6-0 x EZ</td> </tr> </tbody> </table>	FLUSH-GLAZED SIZES	LITE KIT SIZES	SF9FEZP 5-0 x EZ 6-0 x EZ	SF9EZP 5-0 x EZ 6-0 x EZ	TF9FEZP 5-0 x EZ 6-0 x EZ	TF9EZP 6-0 x EZ																				
FLUSH-GLAZED SIZES	LITE KIT SIZES																																	
SF9FSP 5-0 x 6-8 5-4 x 6-8 5-8 x 6-8 6-0 x 6-8	SF9SP 5-0 x 6-8 5-4 x 6-8 5-8 x 6-8 6-0 x 6-8																																	
TF9FSP 5-0 x 6-8 5-4 x 6-8 5-8 x 6-8 6-0 x 6-8	TF9SP 5-0 x 6-8 5-4 x 6-8 5-8 x 6-8 6-0 x 6-8																																	
FLUSH-GLAZED SIZES	LITE KIT SIZES																																	
SF9FEZP 5-0 x EZ 6-0 x EZ	SF9EZP 5-0 x EZ 6-0 x EZ																																	
TF9FEZP 5-0 x EZ 6-0 x EZ	TF9EZP 6-0 x EZ																																	
<p>20FMB/20MB</p>  <p>Miniblinds</p> <p>SF TF</p>	<table border="1"> <thead> <tr> <th>FLUSH-GLAZED SIZES</th> <th>LITE KIT SIZES</th> </tr> </thead> <tbody> <tr> <td>SF20FMBSP 5-0 x 6-8 5-4 x 6-8 6-0 x 6-8</td> <td>SF20MBSP 5-0 x 6-8 5-4 x 6-8 5-8 x 6-8 6-0 x 6-8</td> </tr> <tr> <td>TF20FMBSP 5-0 x 6-8 5-4 x 6-8 6-0 x 6-8</td> <td>TF20MBSP 5-0 x 6-8 5-4 x 6-8 5-8 x 6-8 6-0 x 6-8</td> </tr> </tbody> </table>	FLUSH-GLAZED SIZES	LITE KIT SIZES	SF20FMBSP 5-0 x 6-8 5-4 x 6-8 6-0 x 6-8	SF20MBSP 5-0 x 6-8 5-4 x 6-8 5-8 x 6-8 6-0 x 6-8	TF20FMBSP 5-0 x 6-8 5-4 x 6-8 6-0 x 6-8	TF20MBSP 5-0 x 6-8 5-4 x 6-8 5-8 x 6-8 6-0 x 6-8	<table border="1"> <thead> <tr> <th>LITE KIT SIZES (ONLY)</th> </tr> </thead> <tbody> <tr> <td>SF20MBEZP 5-0 x EZ 6-0 x EZ</td> </tr> <tr> <td>TF20MBEZP 6-0 x EZ</td> </tr> </tbody> </table>	LITE KIT SIZES (ONLY)	SF20MBEZP 5-0 x EZ 6-0 x EZ	TF20MBEZP 6-0 x EZ																							
FLUSH-GLAZED SIZES	LITE KIT SIZES																																	
SF20FMBSP 5-0 x 6-8 5-4 x 6-8 6-0 x 6-8	SF20MBSP 5-0 x 6-8 5-4 x 6-8 5-8 x 6-8 6-0 x 6-8																																	
TF20FMBSP 5-0 x 6-8 5-4 x 6-8 6-0 x 6-8	TF20MBSP 5-0 x 6-8 5-4 x 6-8 5-8 x 6-8 6-0 x 6-8																																	
LITE KIT SIZES (ONLY)																																		
SF20MBEZP 5-0 x EZ 6-0 x EZ																																		
TF20MBEZP 6-0 x EZ																																		
<p>20V</p>  <p>Vented w/Screen Bottom moves up and down. Top does not. Lite Kit Available in White Only</p> <p>SF TF</p>	<table border="1"> <thead> <tr> <th>LITE KIT SIZES</th> </tr> </thead> <tbody> <tr> <td>SF20VSP 5-0 x 6-8 5-4 x 6-8 5-8 x 6-8 6-0 x 6-8</td> </tr> <tr> <td>TF20VSP 5-0 x 6-8 5-4 x 6-8 5-8 x 6-8 6-0 x 6-8</td> </tr> </tbody> </table>	LITE KIT SIZES	SF20VSP 5-0 x 6-8 5-4 x 6-8 5-8 x 6-8 6-0 x 6-8	TF20VSP 5-0 x 6-8 5-4 x 6-8 5-8 x 6-8 6-0 x 6-8	<table border="1"> <thead> <tr> <th>LITE KIT SIZES (ONLY)</th> </tr> </thead> <tbody> <tr> <td>SF20VEZP 6-0 x EZ</td> </tr> <tr> <td>TF20VEZP 6-0 x EZ</td> </tr> </tbody> </table>	LITE KIT SIZES (ONLY)	SF20VEZP 6-0 x EZ	TF20VEZP 6-0 x EZ																										
LITE KIT SIZES																																		
SF20VSP 5-0 x 6-8 5-4 x 6-8 5-8 x 6-8 6-0 x 6-8																																		
TF20VSP 5-0 x 6-8 5-4 x 6-8 5-8 x 6-8 6-0 x 6-8																																		
LITE KIT SIZES (ONLY)																																		
SF20VEZP 6-0 x EZ																																		
TF20VEZP 6-0 x EZ																																		
<p>CODEL DOORS</p>	<table border="1"> <thead> <tr> <th></th> <th>NET UNIT WIDTH</th> <th>INSWING ADJ. SILL</th> <th>OUTSWING BUMPER SILL</th> </tr> </thead> <tbody> <tr> <td>5-0 x 6-8</td> <td>62-3/4"</td> <td>81-3/4"</td> <td>80-1/2"</td> </tr> <tr> <td>5-4 x 6-8</td> <td>66-3/4"</td> <td>81-3/4"</td> <td>80-1/2"</td> </tr> <tr> <td>5-8 x 6-8</td> <td>70-3/4"</td> <td>81-3/4"</td> <td>80-1/2"</td> </tr> <tr> <td>6-0 x 6-8</td> <td>74-3/4"</td> <td>81-3/4"</td> <td>80-1/2"</td> </tr> </tbody> </table> <p><i>*Screen not available on outswings.</i></p>		NET UNIT WIDTH	INSWING ADJ. SILL	OUTSWING BUMPER SILL	5-0 x 6-8	62-3/4"	81-3/4"	80-1/2"	5-4 x 6-8	66-3/4"	81-3/4"	80-1/2"	5-8 x 6-8	70-3/4"	81-3/4"	80-1/2"	6-0 x 6-8	74-3/4"	81-3/4"	80-1/2"	<table border="1"> <thead> <tr> <th></th> <th>NET UNIT WIDTH</th> <th>INSWING ADJ. SILL</th> <th>OUTSWING BUMPER SILL</th> </tr> </thead> <tbody> <tr> <td>5-0 x EZ-FIT</td> <td>59-3/4"</td> <td>79-1/2"</td> <td>78-3/4"</td> </tr> <tr> <td>6-0 x EZ-FIT</td> <td>71-3/4"</td> <td>79-1/2"</td> <td>78-3/4"</td> </tr> </tbody> </table> <p><i>*Screen not available on outswings.</i></p>		NET UNIT WIDTH	INSWING ADJ. SILL	OUTSWING BUMPER SILL	5-0 x EZ-FIT	59-3/4"	79-1/2"	78-3/4"	6-0 x EZ-FIT	71-3/4"	79-1/2"	78-3/4"
	NET UNIT WIDTH	INSWING ADJ. SILL	OUTSWING BUMPER SILL																															
5-0 x 6-8	62-3/4"	81-3/4"	80-1/2"																															
5-4 x 6-8	66-3/4"	81-3/4"	80-1/2"																															
5-8 x 6-8	70-3/4"	81-3/4"	80-1/2"																															
6-0 x 6-8	74-3/4"	81-3/4"	80-1/2"																															
	NET UNIT WIDTH	INSWING ADJ. SILL	OUTSWING BUMPER SILL																															
5-0 x EZ-FIT	59-3/4"	79-1/2"	78-3/4"																															
6-0 x EZ-FIT	71-3/4"	79-1/2"	78-3/4"																															

SF Smooth Fiberglass TF Textured Fiberglass

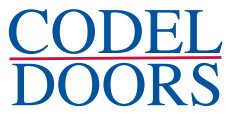

SF20F Double w/Right Opening and sidelites. Carbon Codel Coatings paint.

TRADITIONAL PATIO DOORS

The Traditional Patio Door is our standard double door but focused on your patio. We also added our maximum width options for each size, to allow you to dream. Available in a variety of sizes in both Smooth and Textured fiberglass, ranging from your standard double door, to adding a sidelite or non-active door as a sidelite. The Traditional Patio Door is a great choice for new construction and remodel projects, and to match your CODEL entry door.

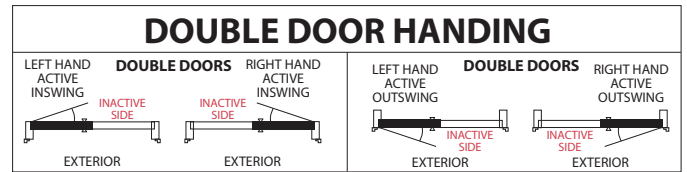

20F/20 Double



Clear/Low-E



20F/20 Double w/Left Non-Opening



Clear/Low-E



Max Width 9'0"

20F/20 Double w/Right Non-Opening



Clear/Low-E



Max Width 9'0"

20F/20 Double w/Left & Right Non-Opening



Clear/Low-E



Max Width 12'0"

9F/9



9 Lite Marginal, GBG Only



9F/9 Double w/Left Non-Opening



9 Lite Marginal, GBG Only



Max Width 9'0"

9F/9 Double w/Right Non-Opening



9 Lite Marginal, GBG Only



Max Width 9'0"

9F/9 Double w/Left & Right Non-Opening



9 Lite Marginal, GBG Only



Max Width 12'0"

10F/10



10 Lite Fixed or GBG



10F/10 Double w/Left Non-Opening



10 Lite Fixed or GBG



Max Width 9'0"

10F/10 Double w/Right Non-Opening



10 Lite Fixed or GBG



Max Width 9'0"

10F/10 Double w/Left & Right Non-Opening



10 Lite Fixed or GBG



Max Width 12'0"

20FMB/20MB



Lite Kit

Raise & Lower Mini Blinds



20FMB/20MB Double w/Left Non-Opening



Raise & Lower Mini Blinds



Max Width 9'0"

20FMB/20MB Double w/Right Non-Opening



Raise & Lower Mini Blinds



Max Width 9'0"

20FMB/20MB Double w/Left & Right Non-Opening



Raise & Lower Mini Blinds



Max Width 12'0"

20V



Vented w/Screen
Lite Kit Available in White Only



20V Double w/Left Non-Opening



Vented w/Screen
Lite Kit Available in White Only



Max Width 9'0"

20V Double w/Right Non-Opening



Vented w/Screen
Lite Kit Available in White Only



Max Width 9'0"

20V Double w/Left & Right Non-Opening



Vented w/Screen
Lite Kit Available in White Only



Max Width 12'0"



SF20F Double w/Left & Right Non-Opening with Bright Codel Coatings paint.



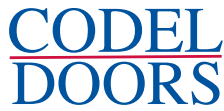

**"EZ-Fit" Double Doors
Net UNIT Sizes**



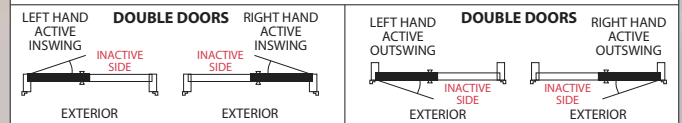

	NET UNIT WIDTH	INSWING ADJ. SILL	OUTSWING BUMPER SILL
5-0 x EZ-FIT	59-3/4"	79-1/2"	78-3/4"
6-0 x EZ-FIT	71-3/4"	79-1/2"	78-3/4"

DOUBLE DOOR HANDING



6-8 EZ-Fit "Retro-Sized" Double Doors w/Astragal (EZ) (both doors open)

GBG Available w/Grids Between Glass
LE Available w/Low-E Glass
■ Extended Leadtime Required

20F/20	10F/10	9F/9	20FMB/20MB	20V																								
 Low-E Only	 10 Lite Fixed or GBG	 9 Lite Marginal, GBG Only	 Lite Kit Raise & Lower Mini Blinds	 Vented w/Screen Lite Kit Available in White Only																								
<table border="1"> <tr> <th>FLUSH-GLAZED SIZES</th> <th>LITE KIT SIZES</th> </tr> <tr> <td>SF20FEZ 5-0 x EZ 6-0 x EZ</td> <td>SF20EZ 5-0 x EZ 6-0 x EZ</td> </tr> <tr> <td>TF20FEZ 5-0 x EZ 6-0 x EZ</td> <td>TF20EZ 6-0 x EZ</td> </tr> </table>	FLUSH-GLAZED SIZES	LITE KIT SIZES	SF20FEZ 5-0 x EZ 6-0 x EZ	SF20EZ 5-0 x EZ 6-0 x EZ	TF20FEZ 5-0 x EZ 6-0 x EZ	TF20EZ 6-0 x EZ	<table border="1"> <tr> <th>FLUSH-GLAZED SIZES</th> <th>LITE KIT SIZES</th> </tr> <tr> <td>SF10FEZ 5-0 x EZ 6-0 x EZ</td> <td>SF10EZ 5-0 x EZ 6-0 x EZ</td> </tr> <tr> <td>TF10FEZ 5-0 x EZ 6-0 x EZ</td> <td>TF10EZ 6-0 x EZ</td> </tr> </table>	FLUSH-GLAZED SIZES	LITE KIT SIZES	SF10FEZ 5-0 x EZ 6-0 x EZ	SF10EZ 5-0 x EZ 6-0 x EZ	TF10FEZ 5-0 x EZ 6-0 x EZ	TF10EZ 6-0 x EZ	<table border="1"> <tr> <th>FLUSH-GLAZED SIZES</th> <th>LITE KIT SIZES</th> </tr> <tr> <td>SF9FEZ 5-0 x EZ 6-0 x EZ</td> <td>SF9EZ 5-0 x EZ 6-0 x EZ</td> </tr> <tr> <td>TF9FEZ 5-0 x EZ 6-0 x EZ</td> <td>TF9EZ 6-0 x EZ</td> </tr> </table>	FLUSH-GLAZED SIZES	LITE KIT SIZES	SF9FEZ 5-0 x EZ 6-0 x EZ	SF9EZ 5-0 x EZ 6-0 x EZ	TF9FEZ 5-0 x EZ 6-0 x EZ	TF9EZ 6-0 x EZ	<table border="1"> <tr> <th>LITE KIT SIZES (ONLY)</th> </tr> <tr> <td>SF20MBEZ 5-0 x EZ 6-0 x EZ</td> </tr> <tr> <td>TF20MBEZ 6-0 x EZ</td> </tr> </table>	LITE KIT SIZES (ONLY)	SF20MBEZ 5-0 x EZ 6-0 x EZ	TF20MBEZ 6-0 x EZ	<table border="1"> <tr> <th>LITE KIT SIZES (ONLY)</th> </tr> <tr> <td>SF20VEZ 6-0 x EZ</td> </tr> <tr> <td>TF20VEZ 6-0 x EZ</td> </tr> </table>	LITE KIT SIZES (ONLY)	SF20VEZ 6-0 x EZ	TF20VEZ 6-0 x EZ
FLUSH-GLAZED SIZES	LITE KIT SIZES																											
SF20FEZ 5-0 x EZ 6-0 x EZ	SF20EZ 5-0 x EZ 6-0 x EZ																											
TF20FEZ 5-0 x EZ 6-0 x EZ	TF20EZ 6-0 x EZ																											
FLUSH-GLAZED SIZES	LITE KIT SIZES																											
SF10FEZ 5-0 x EZ 6-0 x EZ	SF10EZ 5-0 x EZ 6-0 x EZ																											
TF10FEZ 5-0 x EZ 6-0 x EZ	TF10EZ 6-0 x EZ																											
FLUSH-GLAZED SIZES	LITE KIT SIZES																											
SF9FEZ 5-0 x EZ 6-0 x EZ	SF9EZ 5-0 x EZ 6-0 x EZ																											
TF9FEZ 5-0 x EZ 6-0 x EZ	TF9EZ 6-0 x EZ																											
LITE KIT SIZES (ONLY)																												
SF20MBEZ 5-0 x EZ 6-0 x EZ																												
TF20MBEZ 6-0 x EZ																												
LITE KIT SIZES (ONLY)																												
SF20VEZ 6-0 x EZ																												
TF20VEZ 6-0 x EZ																												

SF Smooth Fiberglass TF Textured Fiberglass

PATIO HANDING

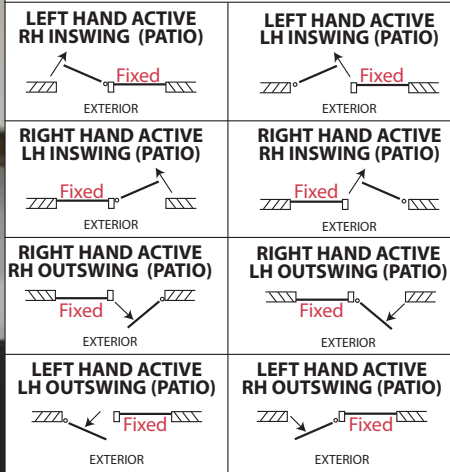

EZ-Fit (Retro) Net UNIT Sizes

	NET UNIT WIDTH	INSWING ADJ. SILL	OUTSWING BUMPER SILL
5-0 x EZ-FIT	59-3/4"	79-1/2"	78-3/4"
6-0 x EZ-FIT	71-3/4"	79-1/2"	78-3/4"

*Screen not available on outswings.

Standard Net UNIT Sizes

	NET UNIT WIDTH	INSWING ADJ. SILL	OUTSWING BUMPER SILL
5-0 x 6-8	62-3/4"	81-3/4"	80-1/2"
5-4 x 6-8	66-3/4"	81-3/4"	80-1/2"
5-8 x 6-8	70-3/4"	81-3/4"	80-1/2"
6-0 x 6-8	74-3/4"	81-3/4"	80-1/2"

*Screen not available on outswings.







GBG Available w/Grids Between Glass

LE Available w/Low-E Glass

■ Extended Leadtime Required

Swinging Patio (SP) (only one door opens)

<p>20F/20</p>  <p>Clear/Low-E</p> <p>SF TF</p> <p>LE</p> <table border="1"> <thead> <tr> <th>FLUSH-GLAZED SIZES</th> <th>LITE KIT SIZES</th> </tr> </thead> <tbody> <tr><td>5-0 x 6-8</td><td>5-0 x 6-8*</td></tr> <tr><td>5-4 x 6-8*</td><td>5-4 x 6-8*</td></tr> <tr><td>5-8 x 6-8*</td><td>5-8 x 6-8*</td></tr> <tr><td>6-0 x 6-8</td><td>6-0 x 6-8</td></tr> </tbody> </table>	FLUSH-GLAZED SIZES	LITE KIT SIZES	5-0 x 6-8	5-0 x 6-8*	5-4 x 6-8*	5-4 x 6-8*	5-8 x 6-8*	5-8 x 6-8*	6-0 x 6-8	6-0 x 6-8	<p>10F/10</p>  <p>10 Lite Fixed or GBG</p> <p>SF TF</p> <p>LE</p> <table border="1"> <thead> <tr> <th>FLUSH-GLAZED SIZES</th> <th>LITE KIT SIZES</th> </tr> </thead> <tbody> <tr><td>5-0 x 6-8</td><td>5-0 x 6-8*</td></tr> <tr><td>5-4 x 6-8*</td><td>5-4 x 6-8*</td></tr> <tr><td>5-8 x 6-8*</td><td>5-8 x 6-8*</td></tr> <tr><td>6-0 x 6-8</td><td>6-0 x 6-8</td></tr> </tbody> </table>	FLUSH-GLAZED SIZES	LITE KIT SIZES	5-0 x 6-8	5-0 x 6-8*	5-4 x 6-8*	5-4 x 6-8*	5-8 x 6-8*	5-8 x 6-8*	6-0 x 6-8	6-0 x 6-8	<p>9F/9</p>  <p>9 Lite Marginal, GBG Only</p> <p>SF TF</p> <p>LE</p> <table border="1"> <thead> <tr> <th>FLUSH-GLAZED SIZES</th> <th>LITE KIT SIZES</th> </tr> </thead> <tbody> <tr><td>5-0 x 6-8</td><td>5-0 x 6-8**</td></tr> <tr><td>5-4 x 6-8*</td><td>5-4 x 6-8**</td></tr> <tr><td>5-8 x 6-8*</td><td>5-8 x 6-8**</td></tr> <tr><td>6-0 x 6-8</td><td>6-0 x 6-8</td></tr> </tbody> </table>	FLUSH-GLAZED SIZES	LITE KIT SIZES	5-0 x 6-8	5-0 x 6-8**	5-4 x 6-8*	5-4 x 6-8**	5-8 x 6-8*	5-8 x 6-8**	6-0 x 6-8	6-0 x 6-8	<p>20FMB/20MB</p>  <p>Lite Kit</p> <p>SF TF</p> <p>LE</p> <table border="1"> <thead> <tr> <th>FLUSH-GLAZED SIZES</th> <th>LITE KIT SIZES</th> </tr> </thead> <tbody> <tr><td>5-0 x 6-8</td><td>5-0 x 6-8</td></tr> <tr><td>5-4 x 6-8*</td><td>5-4 x 6-8*</td></tr> <tr><td>5-8 x 6-8*</td><td>5-8 x 6-8*</td></tr> <tr><td>6-0 x 6-8</td><td>6-0 x 6-8</td></tr> </tbody> </table>	FLUSH-GLAZED SIZES	LITE KIT SIZES	5-0 x 6-8	5-0 x 6-8	5-4 x 6-8*	5-4 x 6-8*	5-8 x 6-8*	5-8 x 6-8*	6-0 x 6-8	6-0 x 6-8	<p>20V</p>  <p>Vented w/Screen Lite Kit Available in White Only</p> <p>SF TF</p> <p>LE</p> <table border="1"> <thead> <tr> <th>LITE KIT SIZES</th> </tr> </thead> <tbody> <tr><td>5-0 x 6-8</td></tr> <tr><td>5-4 x 6-8*</td></tr> <tr><td>5-8 x 6-8*</td></tr> <tr><td>6-0 x 6-8</td></tr> </tbody> </table>	LITE KIT SIZES	5-0 x 6-8	5-4 x 6-8*	5-8 x 6-8*	6-0 x 6-8
FLUSH-GLAZED SIZES	LITE KIT SIZES																																																
5-0 x 6-8	5-0 x 6-8*																																																
5-4 x 6-8*	5-4 x 6-8*																																																
5-8 x 6-8*	5-8 x 6-8*																																																
6-0 x 6-8	6-0 x 6-8																																																
FLUSH-GLAZED SIZES	LITE KIT SIZES																																																
5-0 x 6-8	5-0 x 6-8*																																																
5-4 x 6-8*	5-4 x 6-8*																																																
5-8 x 6-8*	5-8 x 6-8*																																																
6-0 x 6-8	6-0 x 6-8																																																
FLUSH-GLAZED SIZES	LITE KIT SIZES																																																
5-0 x 6-8	5-0 x 6-8**																																																
5-4 x 6-8*	5-4 x 6-8**																																																
5-8 x 6-8*	5-8 x 6-8**																																																
6-0 x 6-8	6-0 x 6-8																																																
FLUSH-GLAZED SIZES	LITE KIT SIZES																																																
5-0 x 6-8	5-0 x 6-8																																																
5-4 x 6-8*	5-4 x 6-8*																																																
5-8 x 6-8*	5-8 x 6-8*																																																
6-0 x 6-8	6-0 x 6-8																																																
LITE KIT SIZES																																																	
5-0 x 6-8																																																	
5-4 x 6-8*																																																	
5-8 x 6-8*																																																	
6-0 x 6-8																																																	

SF Smooth Fiberglass TF Textured Fiberglass

*Not available EZ-Fit (Retro) size.

NEW



Patina Caming
Standard Low-E with Argon

2022

6/8 & 7/0 Eastmont Collection

Eastmont SFEAS-4401P door with (2) SFEAS-16080 Sidelites with Carbon paint.



EAS-230
6-8 (26 28 210 30)
7-0 (28 30) SF Only



EAS-430
6-8 (28 210 30)
7-0 (28 30) SF Only



EAS-4301P
(28 210 30)



EAS-4301PC
(28 30)



EAS-4301PSHK
(28 210 30)

No matching sidelite available.



EAS-440
(28 30)



EAS-4401P
(30)



EAS-460
6-8 (28 210 30)
7-0 (28 30) SF Only



EAS-230
6-8 (12" & 14")
7-0 (14") SF Only



EAS-240
(12" & 14")



EAS-160
6-8 (12" & 14")
7-0 (14") SF Only

SF Smooth Fiberglass TF Textured Fiberglass FG Fir Grain Textured Fiberglass

8/0 Eastmont Collection



EAS-24080
(SF - 28 30)
(TF - 30)



EAS-44080
(SF - 28 30)
(TF - 30)



EAS-440801P
(30)



EAS-46080
(30 36)



EAS-460801P
(30)



EAS-24080
(12" & 14")



EAS-16080
(12" & 14")

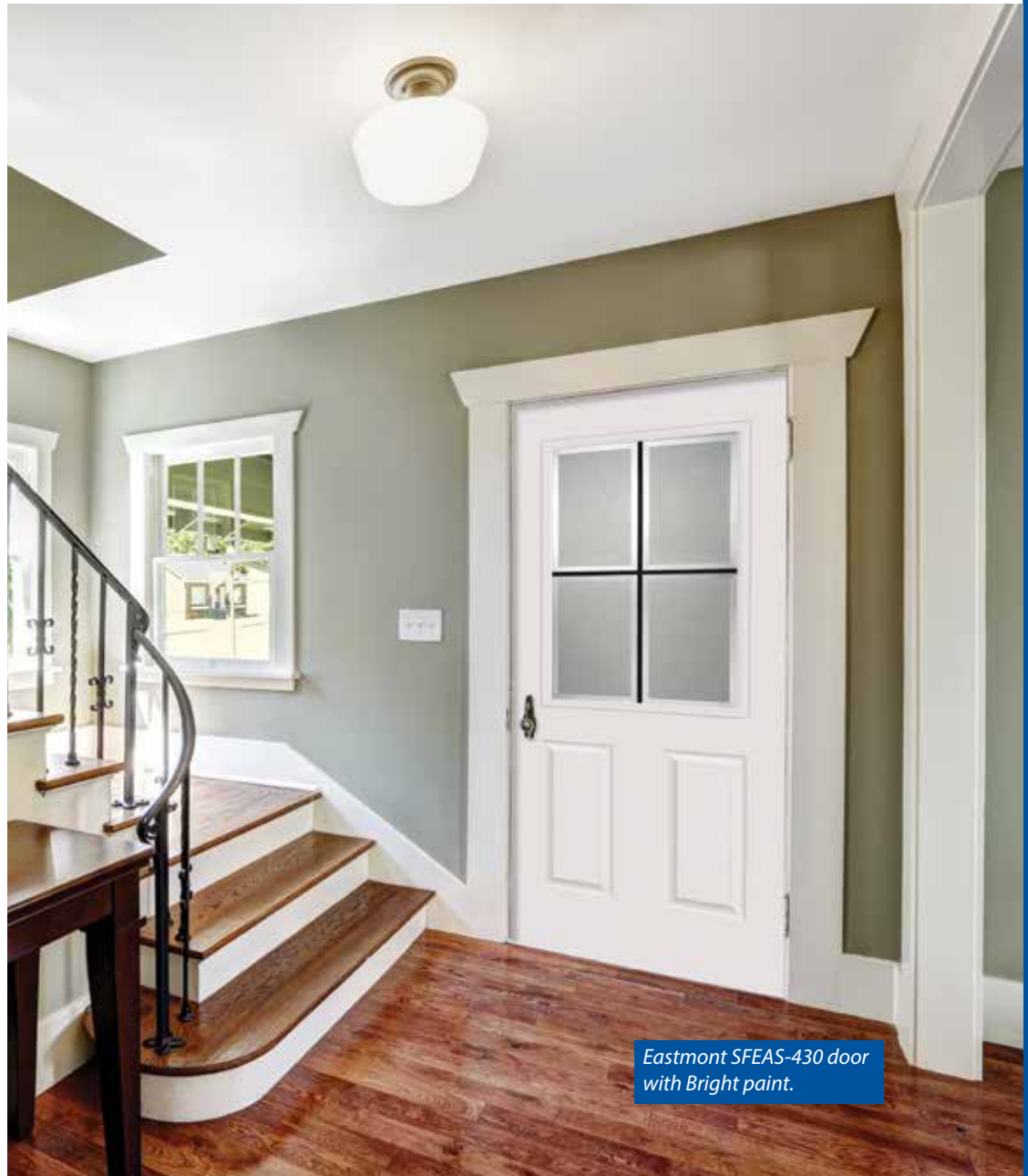

Eastmont SFEAS-430 door
with Bright paint.

NEW

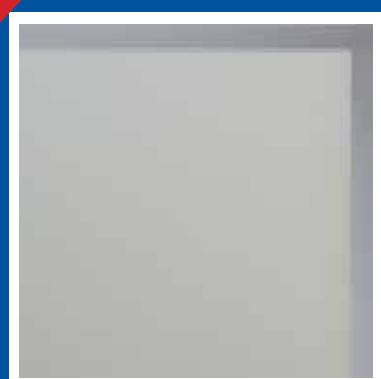

Sandblast w/Clear Border
Standard Low-E with Argon



6/8 & 7/0 Perimeter Collection

*Perimeter SFPER-460 door.
Paint is not Codel Coatings.*



PER-230
6-8 (26 28 210 30)
7-0 (28 30) SF Only



PER-430
6-8 (28 210 30)
7-0 (28 30) SF Only



PER-4301P
(28 210 30)



PER-4301PC
(28 30)



PER-4301PSHK
(28 210 30)

No matching sidelite available.



PER-440
(28 30)



PER-4401P
(30)



PER-460
6-8 (28 210 30)
7-0 (28 30) SF Only



PER-230
6-8 (12" & 14")
7-0 (14") SF Only

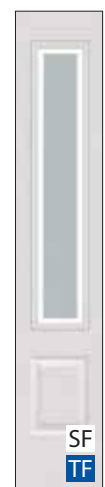

PER-240
(12" & 14")



PER-160
6-8 (12" & 14")
7-0 (14") SF Only

8/0 Perimeter Collection



PER-24080
(SF - 28 30)
(TF - 30)



PER-44080
(SF - 28 30)
(TF - 30)



PER-440801P
(30)

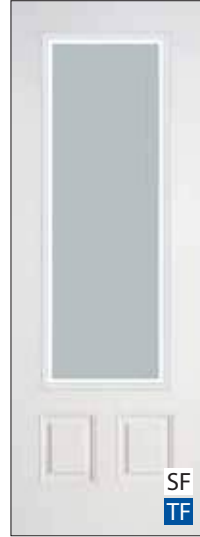

PER-46080
(30 36)

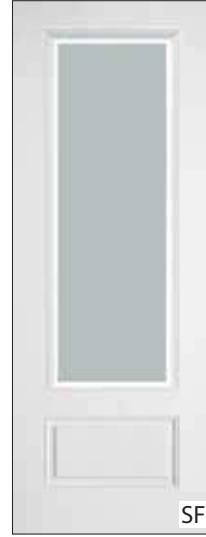

PER-460801P
(30)

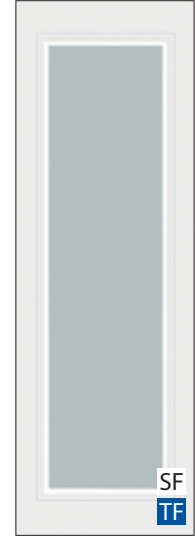

PER-480
(28 30 36)



PER-24080
(12" & 14")

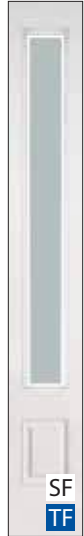

PER-16080
(12" & 14")

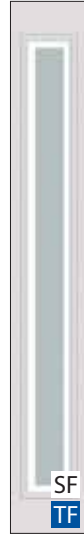

PER-280
(12" & 14")



Perimeter SPPER-480 doors
with Bright paint.

NEW



Patina Caming
Standard Low-E with Argon

6/8 & 7/0 Royston Collection

Royston TFROY-460 door with (2) TFROY-160 sidelites and TFROY-6312 transom. Paint color shown is not Codel Coatings.



ROY-230 6-8 (26 28 210 30) 7-0 (28 30) SF Only
ROY-430 6-8 (28 210 30) 7-0 (28 30) SF Only
ROY-4301P (28 210 30)
ROY-4301PC (28 30)
ROY-4301PSHK (28 210 30)
ROY-440 (28 30)

No matching sidelite available.



ROY-4401P (30)
ROY-460 6-8 (28 210 30) 7-0 (28 30) SF Only
ROY-200 (30)
ROY-230 6-8 (12" & 14") 7-0 (14") SF Only
ROY-240 (12" & 14")
ROY-160 6-8 (12" & 14") 7-0 (14") SF Only

Shown with optional C-21P shelf.

SF Smooth Fiberglass TF Textured Fiberglass FG Fir Grain Textured Fiberglass

8/0 Royston Collection

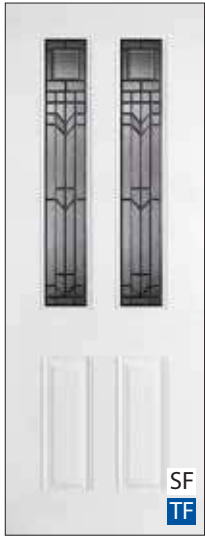

ROY-24080
(SF - 28' 30")
(TF - 30")



ROY-44080
(SF - 28' 30")
(TF - 30")



ROY-440801P
(30")



ROY-46080
(30" 36")



ROY-460801P
(30")



ROY-24080
(12" & 14")

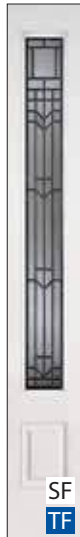

ROY-16080
(12" & 14")

Royston Transom



■ ROY-6312 / ROY-6712 / ROY-7212

■ Extended Leadtime Required.
Refer to Page 114 for Transom Size Information.



Royston TFROY-200 doors and TFROY-6312 transom.
Stain color shown is not Codel Coatings.

NEW



6/8 & 7/0 Sable Collection

Sable TFSAB-460 door and (2) TFSAB-160 sidelites. Stain color is not Codel Coatings.



SAB-230
6-8 (26 28 210 30)
7-0 (28 30) SF Only



SAB-430
6-8 (28 210 30)
7-0 (28 30) SF Only



SAB-4301P
(28 210 30)



SAB-4301PC
(28 30)



SAB-4301PSHK
(28 210 30)



SAB-440
(28 30)

No matching sidelite available.

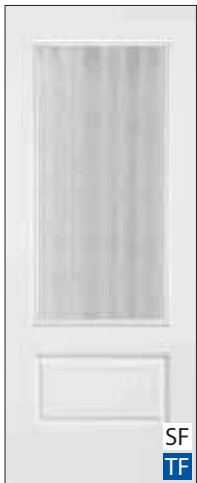

SAB-4401P
(30)



SAB-460
6-8 (28 210 30)
7-0 (28 30) SF Only



SAB-200
(30)

Shown with optional C-21P shelf.



SAB-230
6-8 (12" & 14")
7-0 (14") SF Only



SAB-240
(12" & 14")



SAB-160
6-8 (12" & 14")
7-0 (14") SF Only

8/0 Sable Collection

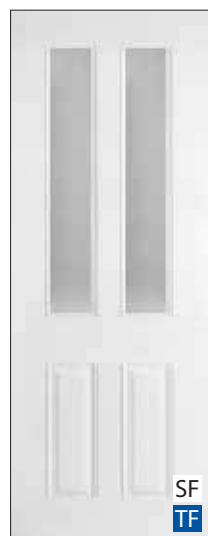

SAB-24080
(SF - 28 30)
(TF - 30)



SAB-44080
(SF - 28 30)
(TF - 30)



SAB-440801P
(30)

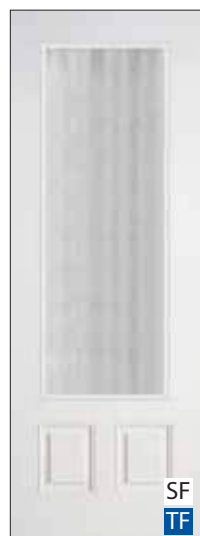

SAB-46080
(30 36)



SAB-460801P
(30)

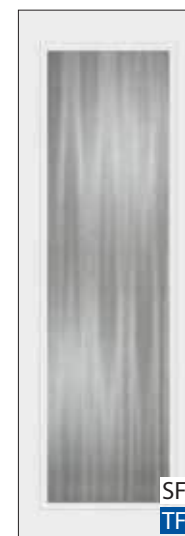

SAB-480
(28 30 36)



SAB-24080
(12" & 14")



SAB-16080
(12" & 14")



SAB-280
(12" & 14")

Sable Transom



■ SAB-6312 / SAB-6712 / SAB-7212

■ Extended Leadtime Required.
Refer to Page 114 for Transom Size Information.



Sable SFSAB-460801P door with Bright paint.



6/8 & 7/0 Adelaide Collection

Adelaide SFADE-440 door with (2) SFADE-240 sidelites and SFADE-6312 transom. Paint color shown is not Codel Coatings.



ADE-230
6-8 (26 28 210 30)
7-0 (28 30) SF Only

SF
TF



ADE-430
6-8 (28 210 30)
7-0 (28 30) SF Only

SF
TF



ADE-4301P
(28 210 30)

SF



ADE-4301PC
(28 30)

SF

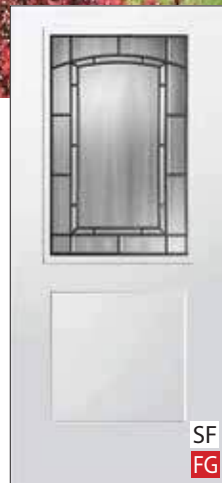

ADE-4301PSHK
(28 210 30)

SF
FG

No matching sidelite available.



ADE-440
(28 30)

SF
TF



ADE-4401P
(30)

SF
TF

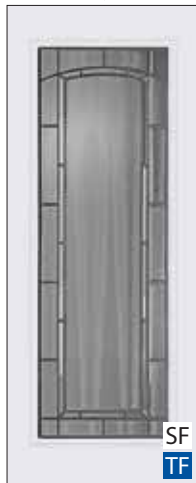

ADE-460
6-8 (28 210 30)
7-0 (28 30) SF Only

SF
TF



ADE-200
(30)

SF
TF

Shown with optional C-21P shelf.



ADE-230
6-8 (12" & 14")
7-0 (14") SF Only

SF
TF

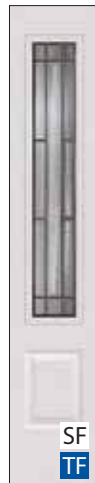

ADE-240
(12" & 14")

SF
TF



ADE-160
6-8 (12" & 14")
7-0 (14") SF Only

SF
TF

8/0 Adelaide Collection

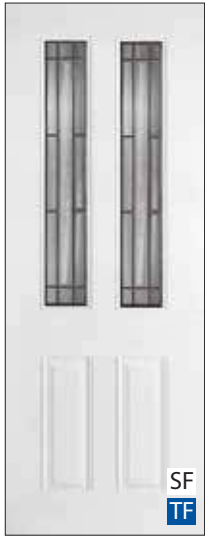

ADE-24080
(SF - 28 30)
(TF - 30)

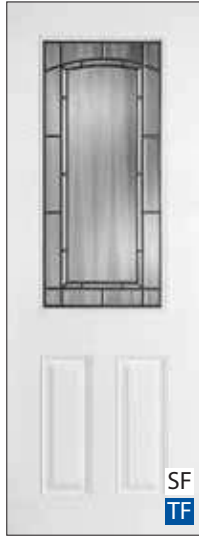

ADE-44080
(SF - 28 30)
(TF - 30)



ADE-440801P
(30)

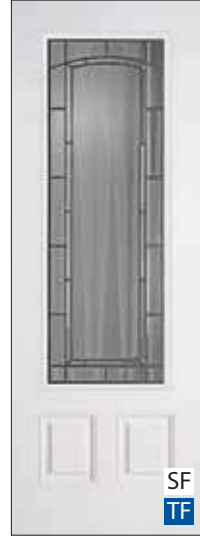

ADE-46080
(30 36)

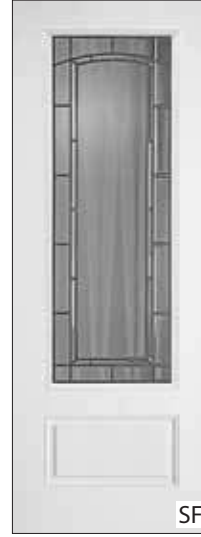

ADE-460801P
(30)

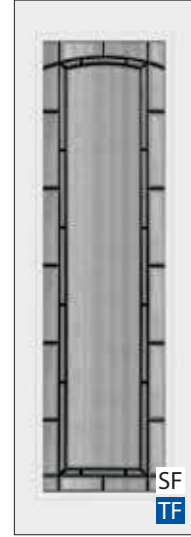

ADE-480
(28 30 36)



ADE-24080
(12" & 14")

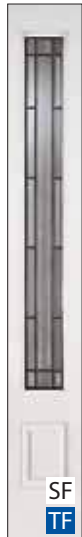

ADE-16080
(12" & 14")



ADE-280
(12" & 14")

Adelaide Transom



■ ADE-6312 / ADE-6712 / ADE-7212

■ Extended Leadtime Required.
Refer to Page 114 for Transom Size Information.

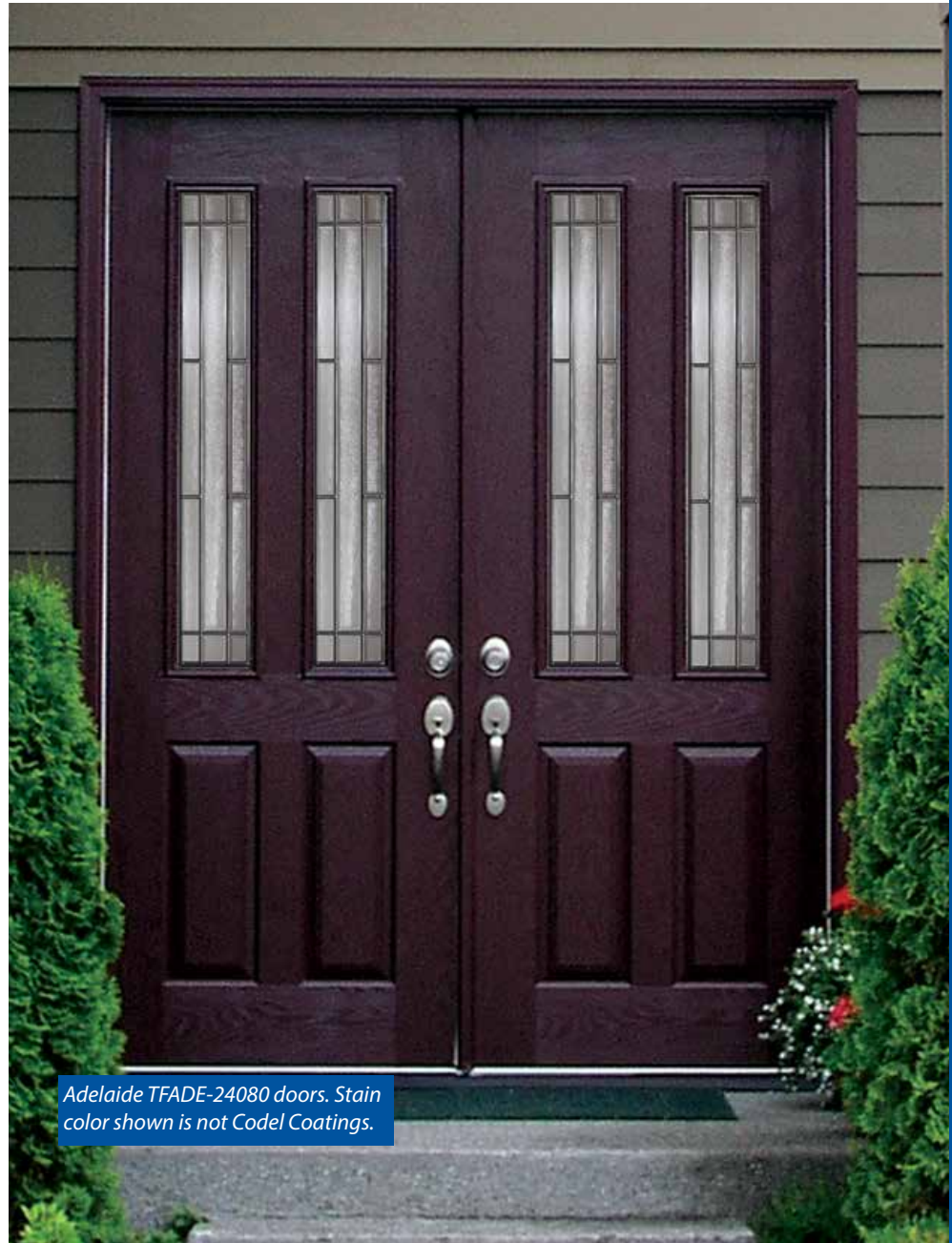

Adelaide TFADE-24080 doors. Stain color shown is not Codel Coatings.

Artisan TFART-480 door. Stain color shown is Mahogany.

6/8 & 7/0 Artisan Collection



ART-230
6-8 (26 28 210 30)
7-0 (28 30) SF Only



ART-430
6-8 (28 210 30)
7-0 (28 30) SF Only



ART-4301P
(28 210 30)



ART-4301PC
(28 30)



ART-4301PSHK
(28 210 30)

No matching sidelite available.



ART-440
(28 30)



ART-4401P
(30)



ART-460
6-8 (28 210 30)
7-0 (28 30) SF Only



Shown with optional C-21P shelf.

ART-200
(30)



ART-230
6-8 (12" & 14")
7-0 (14") SF Only



ART-240
(12" & 14")

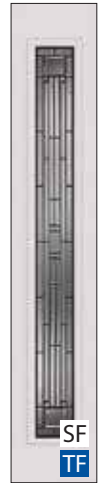

ART-160
6-8 (12" & 14")
7-0 (14") SF Only

8/0 Artisan Collection

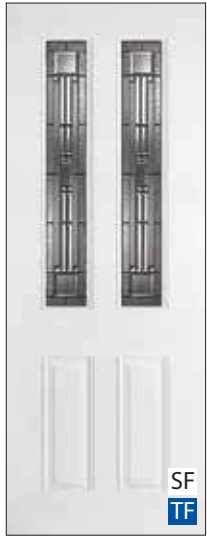

ART-24080
(SF - 28 30)
(TF - 30)



ART-44080
(SF - 28 30)
(TF - 30)



ART-440801P
(30)

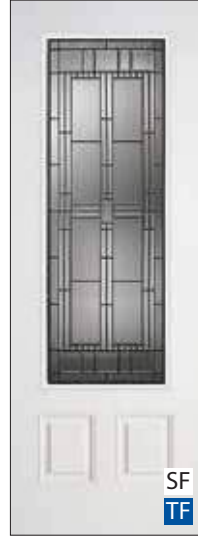

ART-46080
(30 36)



ART-460801P
(30)



ART-480
(28 30 36)



ART-24080
(12" & 14")

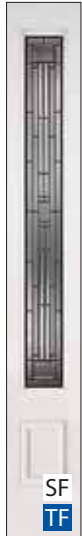

ART-16080
(12" & 14")



ART-280
(12" & 14")

Artisan Transom

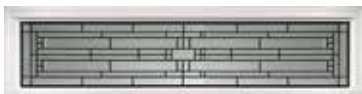

■ ART-6312 / ART-6712 / ART-4212 / ART-7212

■ Extended Leadtime Required.
Refer to Page 114 for Transom Size Information.

**CODEL
DOORS**



Artisan TFART-46080 doors. Stain color shown is not Codel Coatings.



6/8 & 7/0 Brentwood Collection

Brentwood SFBRE-460801P door and (2) SFBRE-16080 sidelites with Bright paint.



BRE-230
6-8 (26 28 210 30)
7-0 (28 30) SF Only



BRE-430
6-8 (28 210 30)
7-0 (28 30) SF Only



BRE-4301P
(28 210 30)



BRE-4301PC
(28 30)



BRE-4301PSHK
(28 210 30)

No matching sidelite available.



BRE-440
(28 30)



BRE-4401P
(30)



BRE-460
6-8 (28 210 30)
7-0 (28 30) SF Only



BRE-200
(30)

Shown with optional C-21P shelf.



BRE-253
(30)



BRE-230
6-8 (12" & 14")
7-0 (14") SF Only



BRE-240
(12" & 14")



BRE-160
6-8 (12" & 14")
7-0 (14") SF Only

8/0 Brentwood Collection

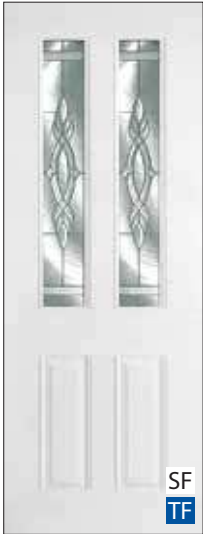

BRE-24080
(SF - 28 30)
(TF - 30)



BRE-44080
(SF - 28 30)
(TF - 30)



BRE-440801P
(30)



BRE-46080
(30 36)



BRE-460801P
(30)



BRE-258
(30)



BRE-25080
(30 36)



Brentwood TFBRE-44080 door,
stain is not Codel Coatings.



BRE-24080
(12" & 14")



BRE-16080
(12" & 14")

Canterbury TFCAN-460 door with (2) TFCAN-160 sidelites & TF CAN-6712 transom. Stain color shown is not Codel Coatings.



Patina Caming
Standard Low-E with Argon

6/8 & 7/0 Canterbury Collection



CAN-230
6-8 (26 28 210 30)
7-0 (28 30) SF Only

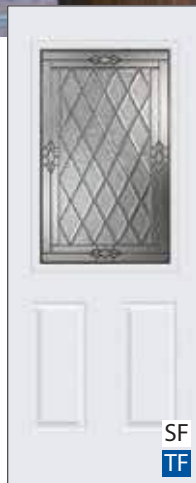

CAN-430
6-8 (28 210 30)
7-0 (28 30) SF Only



CAN-4301P
(28 210 30)



CAN-4301PC
(28 30)



CAN-4301PSHK
(28 210 30)

No matching sidelite available



CAN-440
(28 30)



CAN-4401P
(30)



CAN-460
6-8 (28 210 30)
7-0 (28 30) SF Only



CAN-949
(30)



CAN-230
6-8 (12" & 14")
7-0 (14") SF Only



CAN-240
(12" & 14")

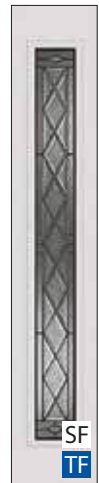

CAN-160
6-8 (12" & 14")
7-0 (14") SF Only

8/0 Canterbury Collection



CAN-24080
(SF - 28 30)
(TF - 30)



CAN-44080
(SF - 28 30)
(TF - 30)



CAN-440801P
(30)



CAN-46080
(30 36)



CAN-460801P
(30)



CAN-24080
(12" & 14")

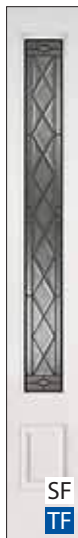

CAN-16080
(12" & 14")

Canterbury SFCAN-46080 door and SFCAN-16080 sidelite with Burgundy paint.



Canterbury Transom



■ CAN-6312 / CAN-6712 / CAN-7212

■ Extended Leadtime Required.
Refer to Page 1014 for Transom Size Information.



Chord SFCHO460801P & SFCHO16080 sidelites with Ivory paint.

6/8 & 7/0 Chord Collection



CHO-230
6-8 (26 28 210 30)
7-0 (28 30) SF Only



CHO-430
6-8 (28 210 30)
7-0 (28 30) SF Only



CHO-4301P
(28 210 30)



CHO-4301PC
(28 30)



CHO-4301PSHK
(28 210 30)



CHO-440
(28 30)

No matching sidelite available.

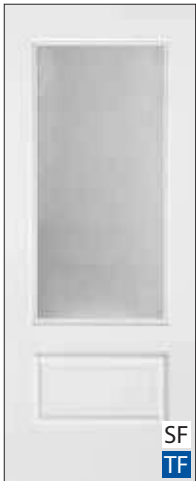

CHO-4401P
(30)



CHO-460
6-8 (28 210 30)
7-0 (28 30) SF Only



CHO-200
(30)

Shown with optional C-21P shelf.



CHO-230
6-8 (12" & 14")
7-0 (14") SF Only



CHO-240
(12" & 14")



CHO-160
6-8 (12" & 14")
7-0 (14") SF Only

SF Smooth Fiberglass TF Textured Fiberglass FG Fir Grain Textured Fiberglass

8/0 Chord Collection

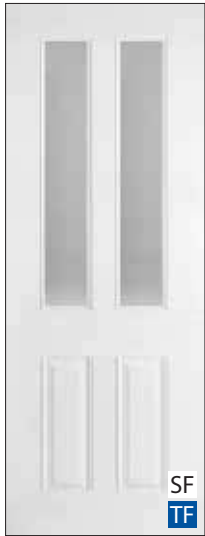

CHO-24080
(SF - 28 30)
(TF - 30)



CHO-44080
(SF - 28 30)
(TF - 30)



CHO-440801P
(30)



CHO-46080
(30 36)



CHO-460801P
(30)

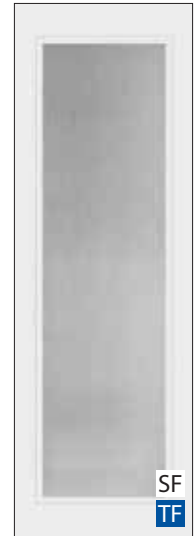

CHO-480
(28 30 36)



CHO-24080
(12" & 14")



CHO-16080
(12" & 14")



CHO-280
(12" & 14")

Chord Transom



■ CHO-6312 / CHO-6712 / CHO-7212

■ Extended Leadtime Required.
Refer to Page 114 for Transom Size Information.



Chord SFCHO-440 door with Bright paint.

Eloquence SFELO-44080 doors with Carbon paint.



6/8 & 7/0 Eloquence Collection



ELO-400
(SF 28 210 30)
(TF 26 28 210 30)



ELO-230
6-8 (26 28 210 30)
7-0 (28 30) SF Only



ELO-430
6-8 (28 210 30)
7-0 (28 30) SF Only



ELO-4301P
(28 210 30)



ELO-4301PC
(28 30)

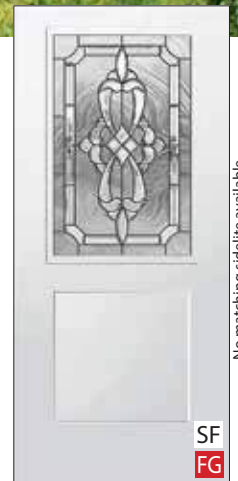

ELO-4301PSHK
(28 210 30)

No matching sidelite available.



ELO-440
(28 30)



ELO-4401P
(30)

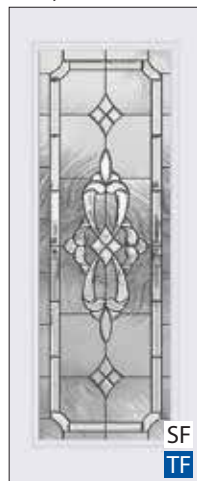

ELO-460
6-8 (28 210 30)
7-0 (28 30) SF Only



ELO-230
6-8 (12" & 14")
7-0 (14") SF Only

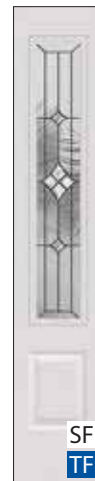

ELO-240
(12" & 14")

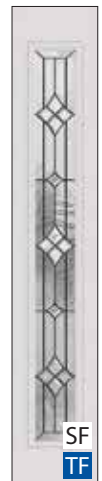

ELO-160
6-8 (12" & 14")
7-0 (14") SF Only

SF Smooth Fiberglass TF Textured Fiberglass FG Fir Grain Textured Fiberglass

8/0 Eloquence Collection

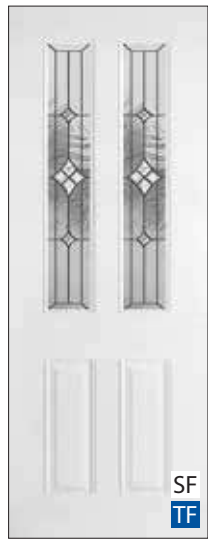

ELO-24080
(SF - 28' 30")
(TF - 30")

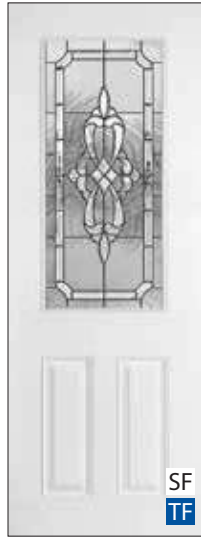

ELO-44080
(SF - 28' 30")
(TF - 30")



ELO-440801P
(30")

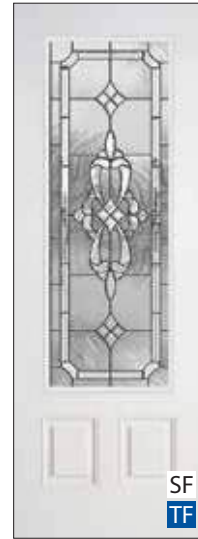

ELO-46080
(30' 36")

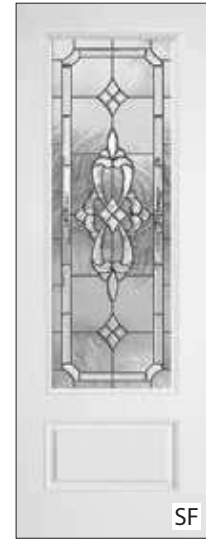

ELO-460801P
(30")



ELO-24080
(12" & 14")

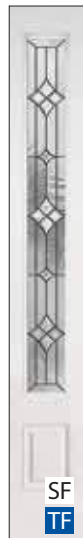

ELO-16080
(12" & 14")



Eloquence SFELO-46080 door and (2) SFELO-16080 sidelites and Burgundy paint.



Zinc Caming
 Brass Caming
 Standard Low-E with Argon

6/8 & 7/0 Floret Collection

Floret TFFLO-24080 door with Medium Oak stain.



FLO-230
6-8 (26 28 210 30)
7-0 (28 30) SF Only



FLO-430
6-8 (28 210 30)
7-0 (28 30) SF Only



FLO-4301P
(28 210 30)



FLO-4301PC
(28 30)



FLO-4301PSHK
(28 210 30)

No matching sidelite available.



FLO-440
(28 30)



FLO-4401P
(30)

SF Smooth Fiberglass TF Textured Fiberglass FG Fir Grain Textured Fiberglass



FLO-1842OV
(30)



FLO-230
6-8 (12" & 14"
7-0 (14") SF Only



FLO-240
(12" & 14")

8/0 Floret Collection



FLO-24080
(SF - 28 30)
(TF - 30)



FLO-44080
(SF - 28 30)
(TF - 30)



FLO-440801P
(30)



FLO-24080
(12" & 14")

Floret Transom



■ FLO-6312 / FLO-6712 / FLO-7212

■ Extended Leadtime Required.
Refer to Page 114 for Transom Size Information.



Floret TFFLO-430 door and (2) TFFLO-230
sidelites with Medium Oak stain.



Patina Caming
Standard Low-E with Argon

6/8 & 7/0 Harlow Collection

Harlow SFHAR-440 door with (2) SFHAR-240 sidelites. Stain color shown is not Codel Coatings.



HAR-230
6-8 (26 28 210 30)
7-0 (28 30) SF Only



HAR-430
6-8 (28 210 30)
7-0 (28 30) SF Only



HAR-4301P
(28 210 30)



HAR-4301PC
(28 30)



HAR-4301PSHK
(28 210 30)



HAR-440
(28 30)

No matching sidelite available.

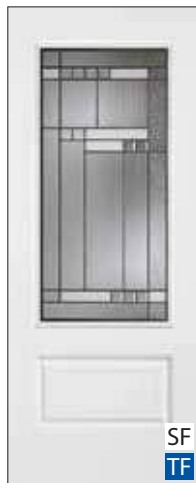

HAR-4401P
(30)



HAR-460
6-8 (28 210 30)
7-0 (28 30) SF Only



HAR-200
(30)

Shown with optional C-21P shelf.



HAR-230
6-8 (12" & 14")
7-0 (14") SF Only

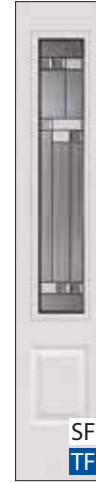

HAR-240
(12" & 14")



HAR-160
6-8 (12" & 14")
7-0 (14") SF Only

8/0 Harlow Collection

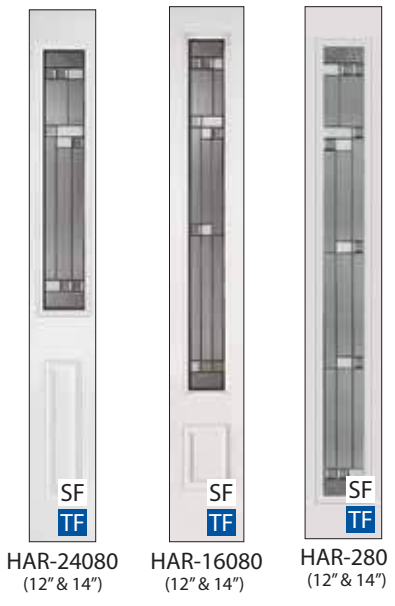

Harlow Transom



■ HAR-6312 / HAR-6712 / HAR-7212

■ Extended Leadtime Required.
 Refer to Page 114 for Transom Size Information.



Harlow SFHAR-430 doors with Bright paint.
 (Cannot mirror glass.)



6/8 & 7/0 Maren Collection

Maren SFMAR-460 door with Carbon paint.

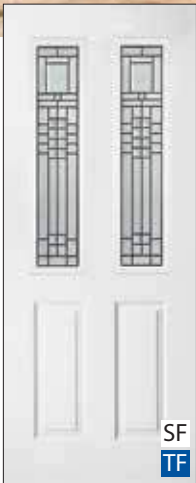

MAR-230
6-8 (26 28 210 30)
7-0 (28 30) SF Only



MAR-430
6-8 (28 210 30)
7-0 (28 30) SF Only



MAR-4301P
(28 210 30)



MAR-4301PC
(28 30)



MAR-4301PSHK
(28 210 30)



MAR-440
(28 30)

No matching sidelite available.



MAR-4401P
(30)

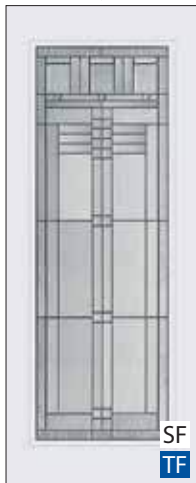

MAR-460
6-8 (28 210 30)
7-0 (28 30) SF Only



MAR-200
(30)

Shown with optional C-21P shelf.



MAR-230
6-8 (12" & 14")
7-0 (14") SF Only

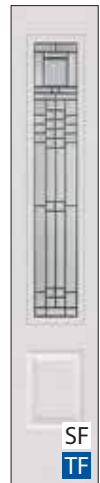

MAR-240
(12" & 14")

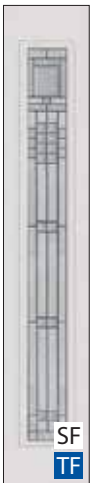

MAR-160
6-8 (12" & 14")
7-0 (14") SF Only

8/0 Maren Collection

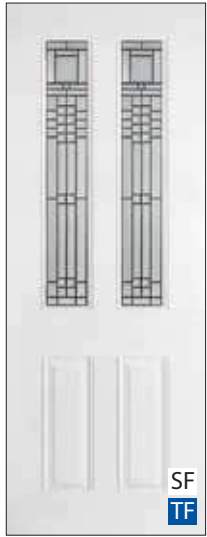

MAR-24080
(SF - 28 30)
(TF - 30)

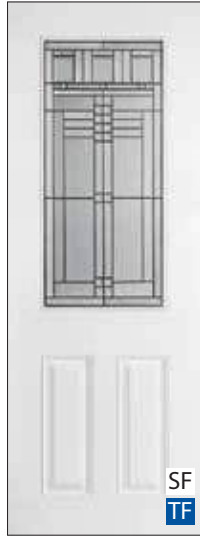

MAR-44080
(SF - 28 30)
(TF - 30)



MAR-440801P
(30)



MAR-46080
(30 36)



MAR-460801P
(30)



MAR-24080
(12" & 14")

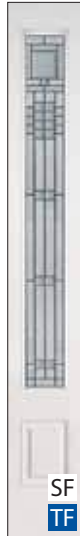

MAR-16080
(12" & 14")

Maren Transom



■ MAR-6312 / MAR-6712 / MAR-7212

■ Extended Leadtime Required.
Refer to Page 114 for Transom Size Information.



Maren SFMAR-200 door with Bright paint.

Modena SFMOD-4401P80 door. Paint color shown is not Codel Coatings.



- Patina Caming
 - Zinc Caming
- Standard Low-E with Argon

6/8 & 7/0 Modena Collection

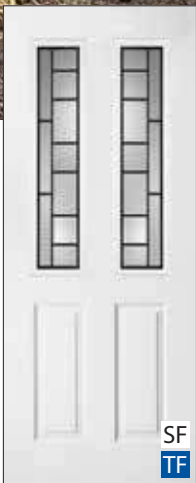

MOD-230
6-8 (26 28 210 30)
7-0 (28 30) SF Only



MOD-430
6-8 (28 210 30)
7-0 (28 30) SF Only



MOD-4301P
(28 210 30)



MOD-4301PC
(28 30)

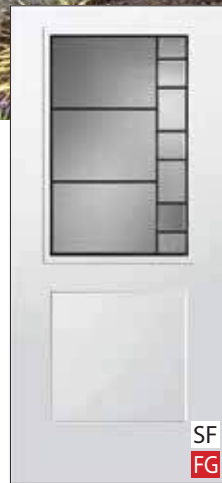

MOD-4301PSHK
(28 210 30)



MOD-440
(28 30)

No matching sidelite available.

SF Smooth Fiberglass TF Textured Fiberglass FG Fir Grain Textured Fiberglass (Zinc Caming Available Upon Request)



MOD-4401P
(30)

SF
TF



MOD-460
6-8 (28 210 30)
7-0 (28 30) SF Only

SF
TF



MOD-200
(30)

SF
TF

Shown with optional C-2-IP shelf.



MOD-230
6-8 (12" & 14")
7-0 (14") SF Only

SF
TF



MOD-240
(12" & 14")

SF
TF



MOD-160
6-8 (12" & 14")
7-0 (14") SF Only

SF
TF

8/0 Modena Collection

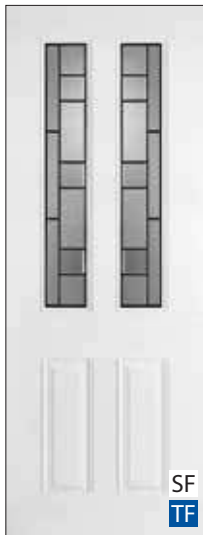

MOD-24080
(SF - 28 30)
(TF - 30)

SF
TF

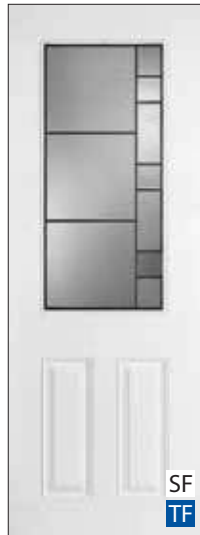

MOD-44080
(SF - 28 30)
(TF - 30)

SF
TF



MOD-440801P
(30)

SF

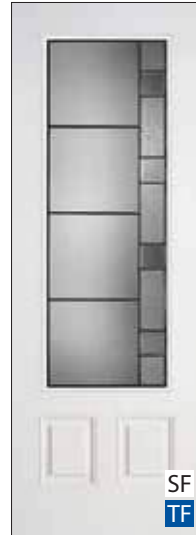

MOD-46080
(30 36)

SF
TF

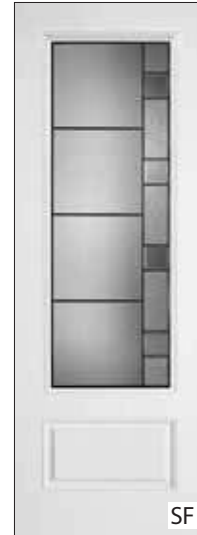

MOD-460801P
(30)

SF



MOD-480
(28 30 36)

SF
TF



MOD-24080
(12" & 14")

SF
TF



MOD-16080
(12" & 14")

SF
TF



MOD-280
(12" & 14")

SF
TF

Modena Transom



■ MOD-6312 / MOD-6712 / MOD-7212

■ Extended Leadtime Required.
Refer to Page 114 for Transom Size Information.



6/8 & 7/0 Narrows Collection

Narrows SFNAR-440 doors with Bright paint.



NAR-230
6-8 (26 28 210 30)
7-0 (28 30) SF Only



NAR-430
6-8 (28 210 30)
7-0 (28 30) SF Only



NAR-4301P
(28 210 30)



NAR-4301PC
(28 30)

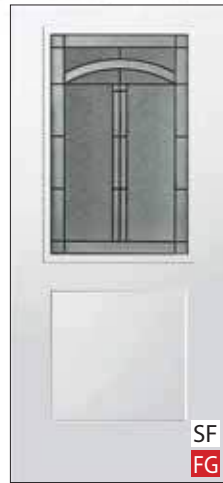

NAR-4301PSHK
(28 210 30)

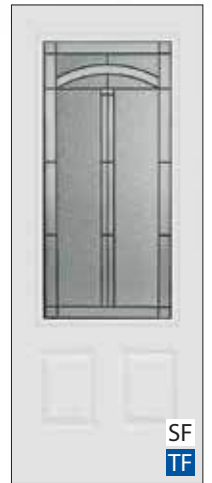

NAR-440
(28 30)

No matching sidelite available.



NAR-4401P
(30)



NAR-460
6-8 (28 210 30)
7-0 (28 30) SF Only



NAR-200
(30)

Shown with optional C-21P shelf.



NAR-230
6-8 (12" & 14")
7-0 (14") SF Only



NAR-240
(12" & 14")

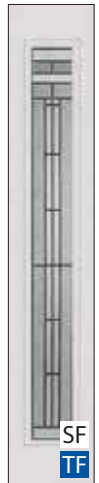

NAR-160
6-8 (12" & 14")
7-0 (14") SF Only

8/0 Narrows Collection

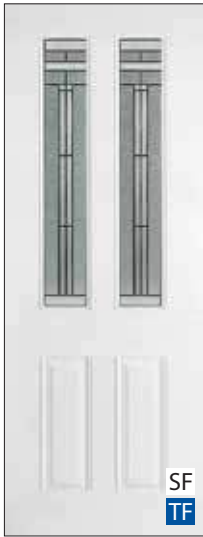

NAR-24080
(SF - 28 30)
(TF - 30)



NAR-44080
(SF - 28 30)
(TF - 30)



NAR-440801P
(30)

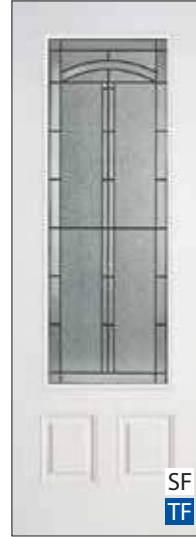

NAR-46080
(30 36)



NAR-460801P
(30)



NAR-24080
(12" & 14")



NAR-16080
(12" & 14")



Narrows SFNAR-430 door and (2) SFNAR-230
sidelites with Hunter paint.



Zinc Caming
Standard Low-E with Argon

6/8 & 7/0 Niagara Collection

Niagara SFNIA-440 door and (2) SFNIA-240 sidelites with Tomato paint.



NIA-400
(SF 28 210 30)
(TF 26 28 210 30)

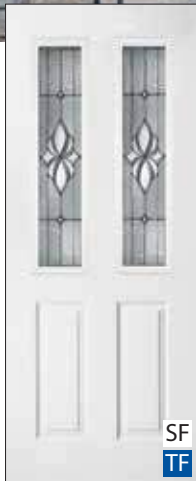

NIA-230
6-8 (26 28 210 30)
7-0 (28 30) SF Only



NIA-430
6-8 (28 210 30)
7-0 (28 30) SF Only



NIA-4301P
(28 210 30)



NIA-4301PC
(28 30)



NIA-4301PSHK
(28 210 30)

No matching sidelite available.



NIA-440
(28 30)



NIA-4401P
(30)



NIA-230
6-8 (12" & 14")
7-0 (14") SF Only



NIA-240
(12" & 14")



Niagara SFNIA-400 door and (2) SFNIA-230 sidelites with Carbon paint.

8/0 Niagara Collection

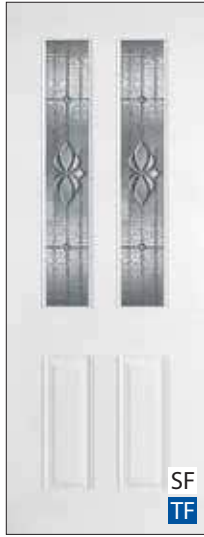

NIA-24080
(SF - 28" 30")
(TF - 30")



NIA-44080
(SF - 28" 30")
(TF - 30")



NIA-440801P
(30")



NIA-24080
(12" & 14")



Niagara SFNIA-230 doors with Bright paint.

CODEL
DOORS



6/8 & 7/0 Satin Etch Collection

Satin Etch TFSAT-460 door. Stain color shown is not Codel Coatings.



SAT-230
6-8 (26 28 210 30)
7-0 (28 30) SF Only



SAT-430
6-8 (28 210 30)
7-0 (28 30) SF Only



SAT-4301P
(28 210 30)



SAT-4301PC
(28 30)



SAT-4301PSHK
(28 210 30)



SAT-440
(28 30)

No matching sidelite available.



SAT-4401P
(30)



SAT-460
6-8 (28 210 30)
7-0 (28 30) SF Only



SAT-200
(30)

Shown with optional C-21P shelf.



SAT-230
6-8 (12" & 14")
7-0 (14") SF Only



SAT-240
(12" & 14")



SAT-160
6-8 (12" & 14")
7-0 (14") SF Only

8/0 Satin Etch Collection

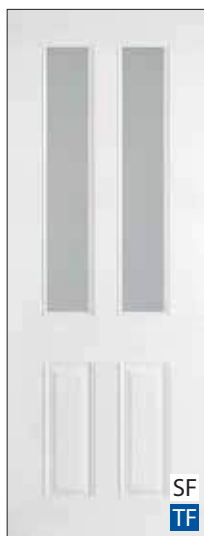

SAT-24080
(SF - 28 30)
(TF - 30)



SAT-44080
(SF - 28 30)
(TF - 30)



SAT-440801P
(30)



SAT-46080
(30 36)



SAT-460801P
(30)



SAT-480
(28 30 36)



SAT-24080
(12" & 14")

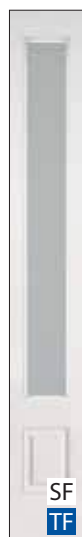

SAT-16080
(12" & 14")

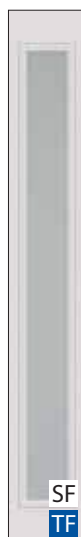

SAT-280
(12" & 14")

Satin Etch Transom



■ SAT-6312 / SAT-6712 / SAT-7212

■ Extended Leadtime Required.
Refer to Page 114 for Transom Size Information.

Waterton SFWAT-46080 door with SFWAT-16080 sidelite. Paint color shown is not Codel Coatings.



6/8 & 7/0 Waterton Collection



WAT-230
6-8 (26 28 210 30)
7-0 (28 30) SF Only



WAT-430
6-8 (28 210 30)
7-0 (28 30) SF Only



WAT-4301P
(28 210 30)



WAT-4301PC
(28 30)



WAT-4301PSHK
(28 210 30)



WAT-440
(28 30)

No matching sidelite available.



WAT-4401P
(30)



WAT-460
6-8 (28 210 30)
7-0 (28 30) SF Only



WAT-64
(30)



WAT-200
(30)

Shown with optional C-21P shelf.



WAT-230
6-8 (12" & 14")
7-0 (14") SF Only



WAT-240
(12" & 14")

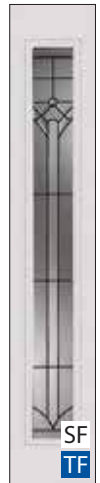

WAT-160
6-8 (12" & 14")
7-0 (14") SF Only

8/0 Waterton Collection

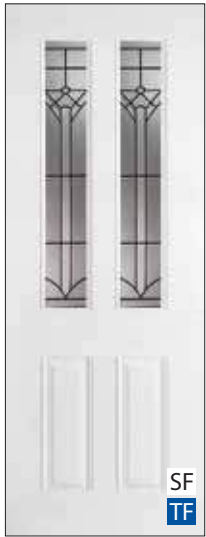

WAT-24080
(SF - 28 30)
(TF - 30)



WAT-44080
(SF - 28 30)
(TF - 30)



WAT-440801P
(30)



WAT-46080
(30 36)



WAT-460801P
(30)



WAT-480
(28 30 36)



WAT-24080
(12" & 14")

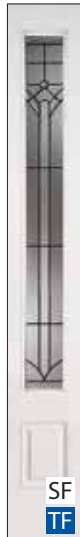

WAT-16080
(12" & 14")



WAT-280
(12" & 14")

Waterton Transom



■ WAT-6312 / WAT-6712 / WAT-7212

■ Extended Leadtime Required.
Refer to Page 114 for Transom Size Information.



Waterton SFWAT-460 door. Paint color shown is not Codel Coatings.

Obscure Glass Options

Codel offers a variety of obscure glass options. Obscurity levels range from glass that lets in plenty of light and definable detail, to obscurity options offering various degrees of privacy.



Chord



Monumental



Narrow Reed



Pinhead



Rain



Sable



Satin Etch



Screen Dot



Travertine



White Laminate

Most Obscure Glass Options are not available in stock and require longer extended leadtimes. Please check with Codel Representative for availability.

Specialty Glass Options

Codel offers additional Specialty glass options. These include sound-proofing glass for noise reduction, thicker glass for added strength, reduction in solar heat gain, and more Low-E options. Contact Codel for more information.



SF20 door glass.

SF64/TF64



SF648



SF3P



SF61



SF81



SF20



SFSL1



SFSL8



SFSL20



Direct Set



More Choices in Specialty Glass

- Reduce noise with sound-proofing glass
- Thicker glass options for added strength and higher solar heat gain coefficient
- Additional Low-E glass options to meet higher U-Values
- GBG with color
- Custom Textures & Custom Decorative Glass
- Extended Leadtimes

Inswing Split Finish (Optional)

Want one color on the outside of your door to complement your home's exterior and a different color on the inside to match your interior? Codel Doors offers 21 paint and 7 stain colors (see back cover) to customize your door for just the right look. Ask your Codel rep. for information.

Inswing (Exterior View)



Inswing Unit - Split Finish

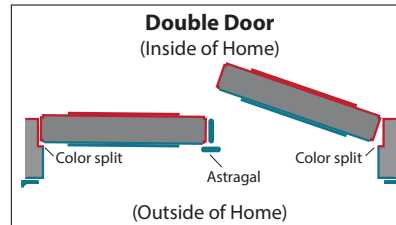
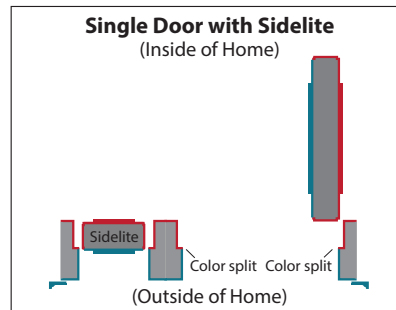
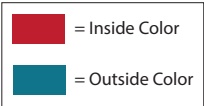

Color is split at center groove of the proud edge.

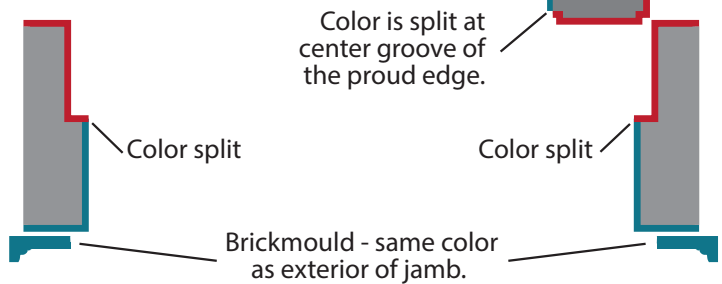

Color samples are reproduced as close as possible, actual color may vary.

Outswing Split Finish (Optional)

Want one color on the outside of your door to complement your home's exterior and a different color on the inside to match your interior? Codel Doors offers 21 paint and 7 stain colors (see back cover) to customize your door for just the right look. Ask your Codel rep. for information.

Outswing (Exterior View)



Outswing Unit - Split Finish

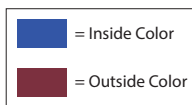

(Inside of Home)

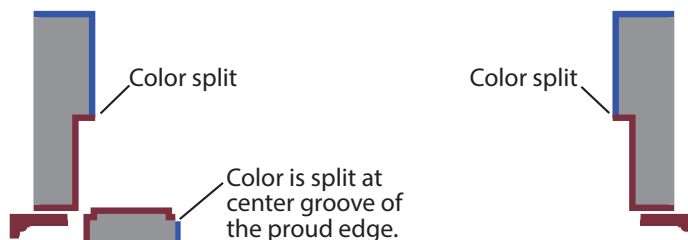

(Outside of Home)

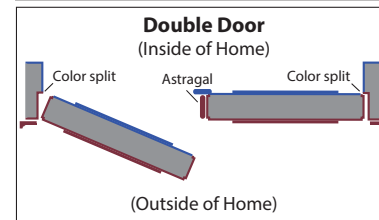
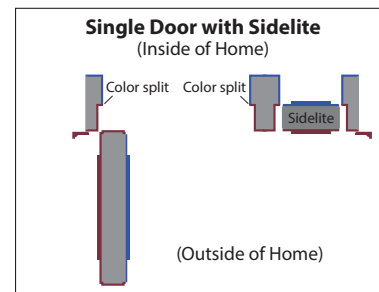
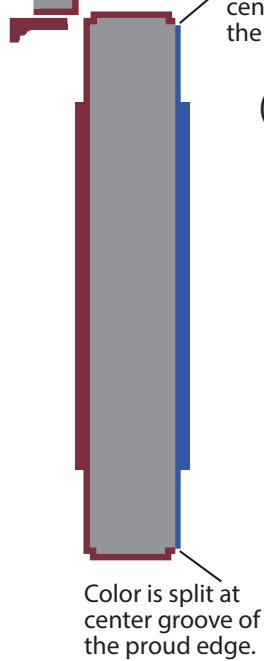

Color samples are reproduced as close as possible, actual color may vary.

WeatherGuard

COMPOSITE FRAME

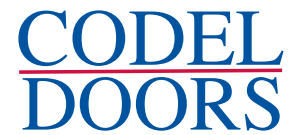

SF20F door with Bright paint.

Codel's WeatherGuard Composite Frame System is an innovative alternative to traditional wood jambs. This poly-fiber doorframe system combines all the strength and convenience of wood with enhanced properties that make it moisture, rot and insect resistant. This unique formulation guarantees that the WeatherGuard frame will not absorb or wick moisture and resists warping, splintering and rotting.

The WeatherGuard product line is available in two varieties. White Cap is a smooth, semi-gloss white that can be painted or left unfinished to compliment the Codel Smooth Fiberglass door. Textured has an embossed grain that can be painted or stained to compliment the Codel Textured Fiberglass door. The advanced WeatherGuard system can be installed the same way as traditional wood jambs.

Exclusive to WeatherGuard is our patented "Seams-Rite" spline that enables the brickmould to be applied to the jamb without using nails. Besides eliminating nail holes, "Seams-Rite" ensures a continuous water barrier.



(Vinyl nailing flange is optional.)



Features & Benefits

- Poly-fiber composite jamb system is an attractive, affordable, and low maintenance option to traditional wood
- Closed cellular structure is a unique formulation that ensures product will not warp, split or absorb moisture
- Greater screw holding power than wood
- Installs the same as traditional wood jambs
- Available in smooth semi-gloss white cap and stainable textured embossed
- Matching mullposts offering sidelite and transom capabilities
- Installation and finishing recommendation label applied to every frame
- Limited lifetime warranty

Adjustable Sill Pan

The Adjustable Sill Pan is a durable, PVC plastic unit that helps you protect your sill and entry door from water damage.

- Sloped weep areas located beneath the jamb-to-sill joint that direct moisture away from areas that could be damaged
- Durable weather-resistant material impervious to rust, corrosion, galvanic corrosion, electrolysis and corrosive coastal areas
- Depths to accommodate most door applications in either 2 x 4 or 2 x 6 construction
- Easy installation with the multiple piece design

**Available in
4-9/16" & 6-9/16"**

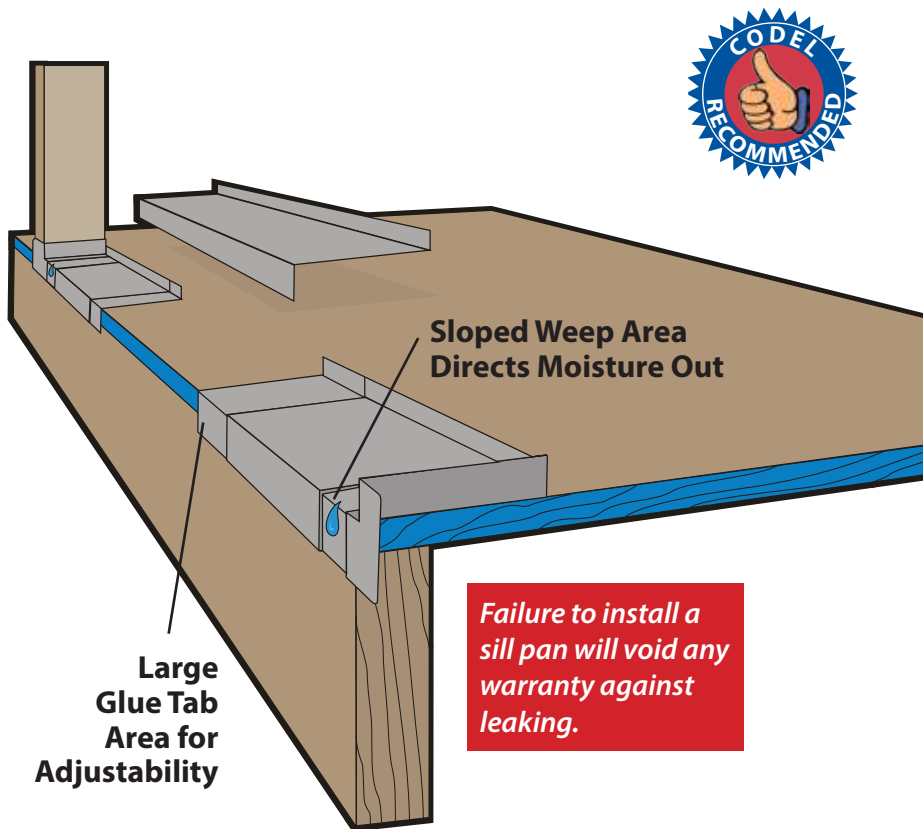

Jamb Options

Available sizes: 4-9/16", 5-1/4", 6-9/16", and 7-1/4".



White Cap Composite Jamb



Textured Tan Composite Jamb

Primed Finger Solid Wood Joint

Our domestic Ponderosa pine door frames are treated with blue acrylic end sealer to prevent wicking. Sealer is applied to bottom of jamb.

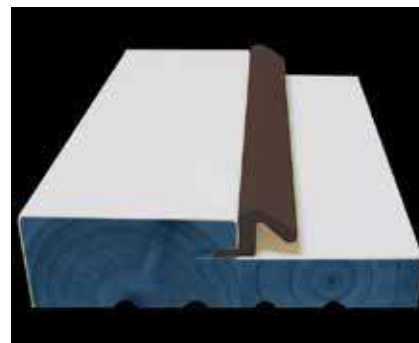

Weatherstrip Options

Brown weatherstrip is the CODEL standard, white is available upon request.



Inswing Water-Shed Sill

- Built-in weep system
- All composite for durability
- Special bumper sweep compensates for gaps; no adjustment needed
- Water-tight butyl end seal gasket



Inswing Adjustable Sill

- High performance Imperial seal technology
- All composite for durability
- Adjustable rail ensuring a tight fit
- Water-tight butyl end seal gasket



Inswing Fixed Sill

- Thermal efficient composite cap
- Durable economic design
- Water-tight butyl end seal gasket



Outswing Bumper Sill

- All-aluminum durability
- High performance outswing design
- Water-tight butyl end seal gasket



Outswing Oak Bumper Sill

- Stain grade hardwood interior
- High performance outswing design
- Water-tight butyl end seal gasket



LowPro Sill (Inswing or Outswing)

- ADA compliant
- Durable all-aluminum design
- Not recommended for high weather exposure



All Sills Available in:



Mill Finish

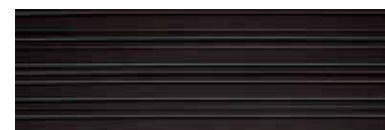

Bronze Finish

High Performance Commercial Grade Ball Bearing Hinges are **Standard** on Codel Fiberglass Doors

Strength and Durability:

Heavy-duty commercial strength hinge, that is much thicker than the standard residential hinge found on most residential fiberglass doors in the industry. This stronger hinge keeps your door true and fit in the opening, and reduces the risk of sagging.

Smooth Operation:

Our heavy-duty hinges come standard with ball bearings, giving your entry door ease of opening and years of quiet operation.

Appearance and Security:

With a thickness of 3.3mm, and $\frac{1}{4}$ radius, these hinges are not only aesthetically pleasing, but are more secure than the traditional residential hinge. These hinges are sealed on the top and bottom, so pin is not removable.



US15 Satin Nickel
(Non-Ferrous or *Self-Closing
Options Also Available)



US26 Bright Chrome
(Non-Ferrous or *Self-Closing
Options Also Available)



US26D Brushed Chrome
(Non-Ferrous or *Self-Closing
Options Also Available)



US1D Black
(Non-Ferrous or *Self-Closing
Options Also Available)



US10B Bronze
(Non-Ferrous or *Self-Closing
Options Also Available)



US3 Brass
(Non-Ferrous or *Self-Closing
Options Also Available)



US4 Satin Brass
(Non-Ferrous or *Self-Closing
Options Also Available)



US5 Antique Brass
(Non-Ferrous or *Self-Closing
Options Also Available)



US32D Stainless Steel
(Non-Ferrous)

*Self-Closing Hinges **ARE NOT** Ball Bearing.

Non-Ferrous hinges help prevent rust and corrosion and are standard on all outswing fiberglass doors.

Steel Door Standard Hinge



Our steel doors come with a standard weight hinge, available in the same color choice options noted above.



MultiPoint Locking Systems

Codel Doors offers MultiPoint Locking Systems of the finest design, most precise machining and highest quality materials, providing homeowners with a secure locking system stronger than traditional deadbolt locks.



Screw Support

Prevents flexing or bending of the gear for life-time performance and smoother operation.



Mishandling Device

Prevents multiple locking points from accidentally firing and potentially damaging door trim. Fully field reversible.



Solid Stainless Steel Deadbolt

Highly corrosion resistant and stronger than traditional deadbolts.



Manual Tongue (Top & Bottom)

While offering security in the locked position, the manual tongue engages into the jamb or mull post and retracts when opened, giving a smooth, clean appearance.



Flush Bolts (Top & Bottom)

(Optional) MultiPoint is available for the inactive door. The flush-bolts operate by the handle on the inactive panel, sending the flush bolts simultaneously into the head and sill, offering smooth and easy operation and securing your entry door.

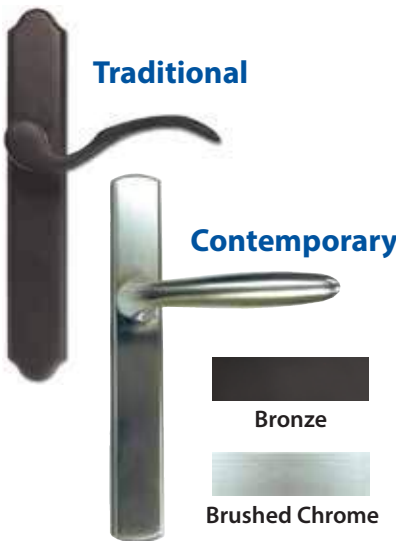

Traditional

Contemporary

Bronze

Brushed Chrome



Euro

Satin Nickel

Bronze

(Deadbolt not shown.)

MultiPoint Hardware Options & Finishes

Features and Benefits

- 300 Series Stainless Steel-Highly corrosion resistant
- Self Lubricating Parts - Last longer by eliminating the need to lubricate locks
- Helps prevent doors from bowing and adds extra security at the same time
- Schlage Keyway

- Only available on Fiberglass door units.
- Not available on cut-down units.



MultiPoint - Grip Series

TONGUE LATCH SYSTEM



Finishes

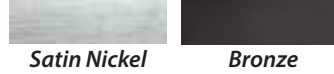

Multiple locking points maintain door panel integrity, prevent door warpage, improve weather resistance and increase security.



Consumer friendly with 1/4 turn deadbolt lock indicator.

Grip & Lever Series Features

- Available for 6/8, 7/0 and 8/0 Doors
- Available in Satin Nickel and Oil Rubbed Bronze
- Conventional Deadbolt and Lever Handle Spacing at 5-1/2"
- Adjustable Strike Plates
- Dummy Sets Available for Double Door Units
- Deadbolts & Levers Meet ANSI Grade 2 Standards
- Schlage Keyway

Savoy



Available in Satin Nickel & Oil Rubbed Bronze finishes.

Windsor



Available in Satin Nickel & Oil Rubbed Bronze finishes.

Lumina



Available in Satin Nickel & Oil Rubbed Bronze finishes.

Only Available on Fiberglass Door Units.

**CODEL
DOORS**



MultiPoint - Lever Series

TRIPLE LATCH SYSTEM



3 latches automatically engage when door closes to prevent door warpage and increase security.

Consumer friendly with 1/4 turn deadbolt lock indicator.



Adjustable strikes for optimum operation.

Extended strike for outswing units.



Classique



Available in Satin Nickel & Oil Rubbed Bronze finishes.

Classique Monaco



Available in Satin Nickel & Oil Rubbed Bronze finishes.

Classique Verona



Available in Satin Nickel & Oil Rubbed Bronze finishes.

Times



Available in Satin Nickel & Oil Rubbed Bronze finishes.

Times Verona



Available in Satin Nickel, Oil Rubbed Bronze & Bright Chrome finishes.

Dahli



Available in Satin Nickel & Oil Rubbed Bronze finishes.

Dahli Verona



Available in Satin Nickel & Oil Rubbed Bronze finishes.

Finishes



Satin Nickel

Bronze



Bright Chrome

(Available on Times Verona ONLY)

Grip & Lever Series Features

- Available for 6/8, 7/0 and 8/0 Doors
- Conventional Deadbolt and Lever Handle Spacing at 5-1/2"
- Adjustable Strike Plates
- Dummy Sets Available for Double Door Units
- Deadbolts & Levers Meet ANSI Grade 2 Standards
- Schlage Keyway

Only Available on Fiberglass Door Units.

Contemporary Door Pulls



Roller Catch

Two heavy-duty roller catches located near the top and bottom of the door ensure a secure closure. Available in Satin Nickel and Oil Rubbed Bronze.



Only Available on Fiberglass Door Units.

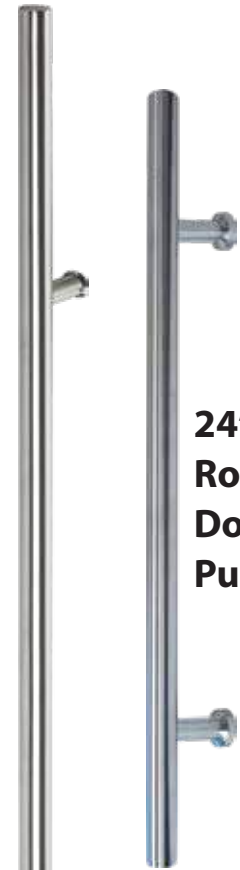

24"
Round
Door
Pull

60"
Round
Door
Pull

Finishes



Satin Nickel



Black

60" Round Door Pull only available in 3-0 lip lite configuration.

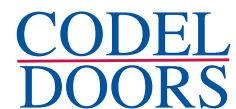

Door Configurations



Single Prehung



Single Prehung with Sidelite on the Strike Side
(This is Codel's STANDARD)

Also available with Sidelite on hinge side.



*Single Prehung with "Direct-Set" Style Sidelite on the Strike Side
(Available with Smooth or Oak Grain Textured Fiberglass Panel ONLY)

Also available with Sidelite on hinge side.



Single Prehung with Two Sidelites

Also available with Direct Sidelite option.



Double Prehung



**Double Prehung with Two Sidelites

Also available with Direct Sidelite option.



***Patio Unit (Hinged off the Mull Post)
R-H Active / L-H Swing



***Patio Unit (Hinged off the Mull Post)
L-H Active / R-H Swing

*Single Prehung with "Direct-Set" Style Sidelite: Available 6/8 and 7/0 Only. 8/0 Direct sidelite available on hinge side.

** Double Prehung Unit: (aka "Pair of Doors" and "French Doors") Both Doors Open - One active door and one inactive (passive) door. The inactive door has an astragal with flush bolts attached to it to keep it stationary when not in use.

*** Patio Unit: (aka "Atrium Unit") Only ONE door opens - One operable door and one fixed door - The fixed door will never open.



Single Prehung with Transom Above



Single Prehung with Sidelite on the Strike Side and Transom Above

Also available with Direct Sidelite option.



Single Prehung with Sidelite on the Hinge Side and Transom Above

Also available with Direct Sidelite option.



Single Prehung with Two Sidelites and Transom Above

Also available with Direct Sidelite option.



**Double Prehung with Transom Above



**Double Prehung with Two Sidelites and Transom Above

Also available with Direct Sidelite option.



***Patio Unit (Hinged off the Jamb) R-H Active / R-H Swing



***Patio Unit (Hinged off the Jamb) L-H Active / L-H Swing

Decorative Transom Sizes & Door Handing

DECORATIVE TRANSOM SIZES			
SERIES	FOR USE OVER	ACTUAL GLASS SIZE	*NET UNIT SIZE
6312	Use Over 3-0 Door w/2 Ea. 12" Sidelites	62-3/4" x 12"	64-3/8" x 95-3/8"
6712	Use Over 3-0 Door w/2 Ea. 14" Sidelites	66-3/4" x 12"	68-3/8" x 95-3/8"
7212	Use Over 6-0 DBL. Door (NO Sidelites)	72-1/4" x 12"	73-7/8" x 95-3/8"

**Net Unit Height includes a 6-8 INSWING prehung with standard fixed or adjustable sill - For OUTSWING Unit, deduct 1-1/4" from Net Unit Height. For 7-0 prehung, add 4" to Net Unit Height. For 8-0 prehung, add 16" to Net Unit Height.*

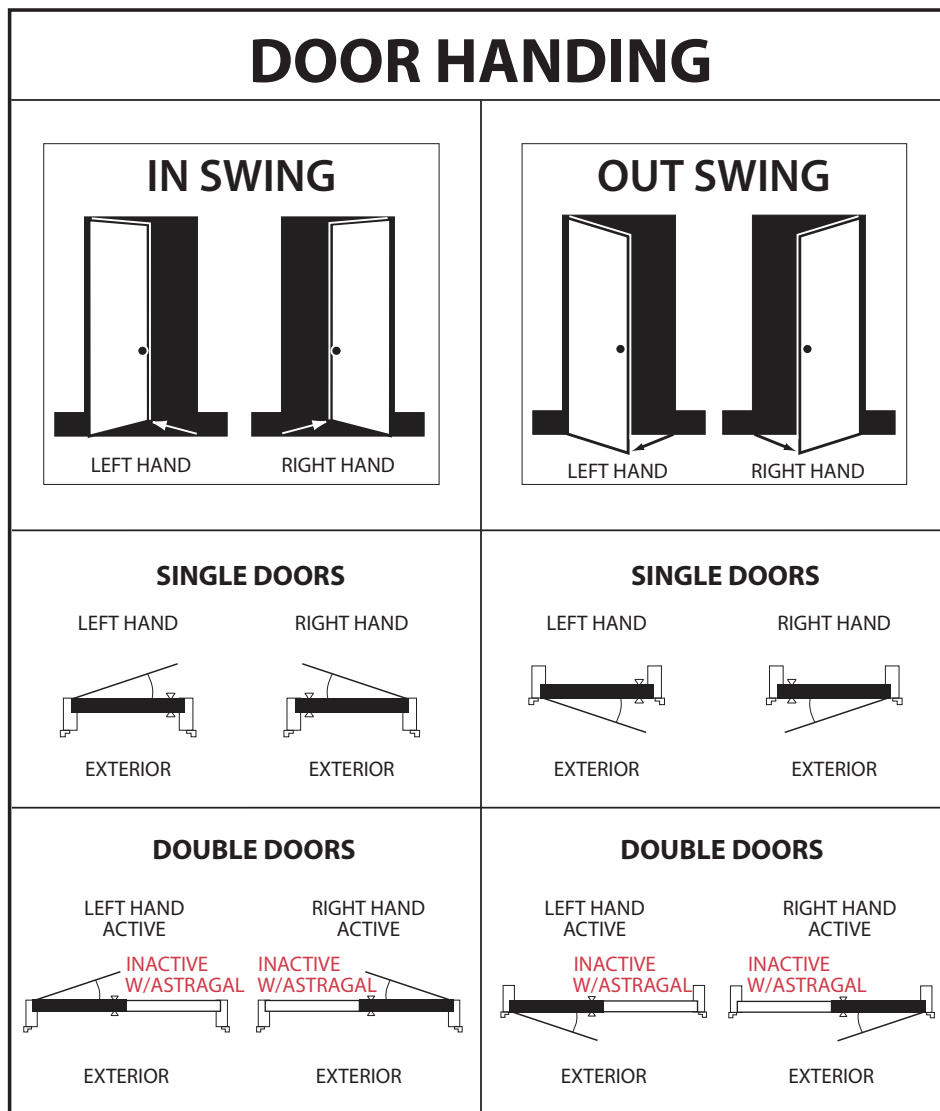

*See page 58 for Patio Door Handing.

Prehung Net Unit Measurements

Add 5/8" to any Net Unit Width and 3/8" to any Net Unit Height **IF IT IS AN OUTSWING** with the NAILING FLANGE.

NET UNIT WIDTHS*							NET UNIT HEIGHTS		
DOOR WIDTH	NET SLAB SIZE	NET UNIT WIDTH	PLUS 1 EACH 12" SIDELITE	PLUS 2 EACH 12" SIDELITES	PLUS 1 EACH 14" SIDELITE	PLUS 2 EACH 14" SIDELITES	FIXED OR ADJ INSWING SILL	BUMPER OUTSWING SILL	ADA LOW-PRO IN/OUT SWING SILL
2-0 x 6-8	23-3/4" x 79"	25-1/2"	38-7/8"	52-1/4"	40-7/8"	56-1/4"	81-3/4"	80-1/2"	81"
2-4 x 6-8	27-3/4" x 79"	29-1/2"	42-7/8"	56-1/4"	44-7/8"	60-1/4"	81-3/4"	80-1/2"	81"
2-6 x 6-8	29-3/4" x 79"	31-1/2"	44-7/8"	58-1/4"	46-7/8"	62-1/4"	81-3/4"	80-1/2"	81"
2-8 x 6-8	31-3/4" x 79"	33-1/2"	46-7/8"	60-1/4"	48-7/8"	64-1/4"	81-3/4"	80-1/2"	81"
2-10 x 6-8	33-3/4" x 79"	35-1/2"	48-7/8"	62-1/4"	50-7/8"	66-1/4"	81-3/4"	80-1/2"	81"
3-0 x 6-8	35-3/4" x 79"	37-1/2"	50-7/8"	64-1/4"	52-7/8"	68-1/4"	81-3/4"	80-1/2"	81"
3-6 x 6-8	41-3/4" x 79"	43-1/2"	56-7/8"	70-1/4"	58-7/8"	74-1/4"	81-3/4"	80-1/2"	81"
4-0 x 6-8	47-3/4" x 79"	49-1/2"	62-7/8"	76-1/4"	64-7/8"	80-1/4"	81-3/4"	80-1/2"	81"
4-0 x 6-8 DBL	--	50"	63-3/8"	76-3/4"	65-3/8"	80-3/4"	81-3/4"	80-1/2"	81"
4-8 x 6-8 DBL	--	58"	71-3/8"	84-3/4"	73-3/8"	88-3/4"	81-3/4"	80-1/2"	81"
5-0 x 6-8 DBL	--	62"	75-3/8"	88-3/4"	77-3/8"	92-3/4"	81-3/4"	80-1/2"	81"
5-4 x 6-8 DBL	--	66"	79-3/8"	92-3/4"	81-3/8"	96-3/4"	81-3/4"	80-1/2"	81"
5-8 x 6-8 DBL	--	70"	83-3/8"	96-3/4"	85-3/8"	100-3/4"	81-3/4"	80-1/2"	81"
6-0 x 6-8 DBL	--	74"	87-3/8"	100-3/4"	89-3/8"	104-3/4"	81-3/4"	80-1/2"	81"
7-0 x 6-8 DBL	--	86"	99-3/8"	112-3/4"	101-3/8"	116-3/4"	81-3/4"	80-1/2"	81"
8-0 x 6-8 DBL	--	98"	111-3/8"	124-3/4"	113-3/8"	128-3/4"	81-3/4"	80-1/2"	81"
2-6 x 7-0	29-3/4" x 83"	31-1/2"	44-7/8"	58-1/4"	46-7/8"	62-1/4"	85-3/4"	84-1/2"	85"
2-8 x 7-0	31-3/4" x 83"	33-1/2"	46-7/8"	60-1/4"	48-7/8"	64-1/4"	85-3/4"	84-1/2"	85"
3-0 x 7-0	35-3/4" x 83"	37-1/2"	50-7/8"	64-1/4"	52-7/8"	68-1/4"	85-3/4"	84-1/2"	85"
5-0 x 7-0 DBL	--	62"	75-3/8"	88-3/4"	77-3/8"	92-3/4"	85-3/4"	84-1/2"	85"
5-4 x 7-0 DBL	--	66"	79-3/8"	92-3/4"	81-3/8"	96-3/4"	85-3/4"	84-1/2"	85"
6-0 x 7-0 DBL	--	74"	87-3/8"	100-3/4"	89-3/8"	104-3/4"	85-3/4"	84-1/2"	85"
2-6 x 8-0	29-3/4" x 95"	31-1/2"	44-7/8"	58-1/4"	46-7/8"	62-1/4"	97-3/4"	96-1/2"	97"
2-8 x 8-0	31-3/4" x 95"	33-1/2"	46-7/8"	60-1/4"	48-7/8"	64-1/4"	97-3/4"	96-1/2"	97"
3-0 x 8-0	35-3/4" x 95"	37-1/2"	50-7/8"	64-1/4"	52-7/8"	68-1/4"	97-3/4"	96-1/2"	97"
3-6 x 8-0	41-3/4" x 95"	43-1/2"	56-7/8"	70-1/4"	58-7/8"	74-1/4"	97-3/4"	96-1/2"	97"
5-0 x 8-0 DBL	--	62"	75-3/8"	88-3/4"	77-3/8"	92-3/4"	97-3/4"	96-1/2"	97"
5-4 x 8-0 DBL	--	66"	79-3/8"	92-3/4"	81-3/8"	96-3/4"	97-3/4"	96-1/2"	97"
6-0 x 8-0 DBL	--	74"	87-3/8"	100-3/4"	89-3/8"	104-3/4"	97-3/4"	96-1/2"	97"
7-0 x 8-0 DBL	--	86"	99-3/8"	112-3/4"	101-3/8"	116-3/4"	97-3/4"	96-1/2"	97"
2-6 x EZ FIT	28-1/4" x 76-3/4"	30"	N/A	N/A	N/A	N/A	79-1/2"	78-1/4"	78-3/4"
3-0 x EZ FIT	34-1/4" x 76-3/4"	36"	N/A	N/A	N/A	N/A	79-1/2"	78-1/4"	78-3/4"
5-0 x EZ DBL	--	59"	N/A	N/A	N/A	N/A	79-1/2"	78-1/4"	78-3/4"
6-0 x EZ DBL	--	71"	N/A	N/A	N/A	N/A	79-1/2"	78-1/4"	78-3/4"

Paint Colors



Stain Colors

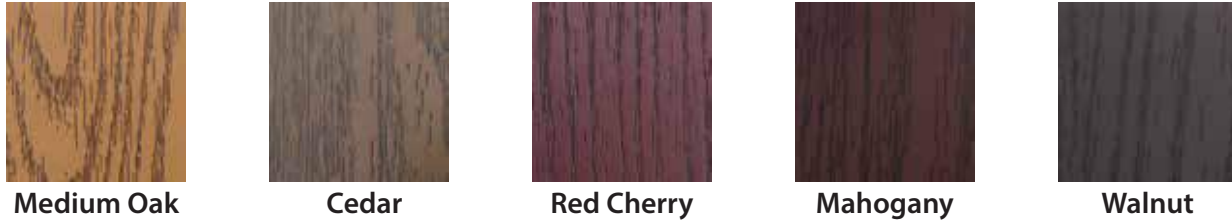

Fir Grain Stain Colors



Available on Fir-Grain Doors (See pages 26-29, & 42-43).

Flush Cherry Wood Stain Colors

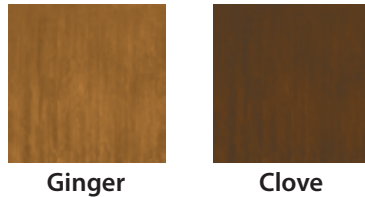

Available on Flush Cherry Doors Only (See page 19).

Why doesn't the color on my product look exactly like it does in the catalog or website?

Due to the limitations of photography, there is no guarantee that your product's colors will have the same appearance as they do in print or online. We always recommend you see an actual sample before deciding on a color choice. Contact a Codel dealer to request a color chip sample.